



MIN 7000TL-X2
MIN 8000TL-X2
MIN 9000TL-X2
MIN 10000TL-X2



Download
Manual



Growatt New Energy

Installation & Operation Manual

Shenzhen Growatt New Energy Co., Ltd
4-13/F, Building A, Sino-German (Europe) Industrial Park,
Hangcheng Ave, Bao'an District, Shenzhen, China

T +86 0755 2747 1942

E service@ginverter.com

W www.ginverter.com

GR-UM-292-A-00

Index

1 Notes on this manual

- 1.1 Validity
- 1.2 Target Group
- 1.3 Additional information
- 1.4 Symbols in this document
- 1.5 Glossary

2 Safety

- 2.1 Intended Use
- 2.2 Qualification of skilled person
- 2.3 Safety instruction
- 2.4 Assembly Warnings
- 2.5 Electrical Connection Warnings
- 2.6 Operation Warnings

3 Product description

- 3.1 TL-X2 Overview
- 3.2 Type label
- 3.3 Size and weight
- 3.4 Storage of Inverter
- 3.5 The advantage of the unit

4 Unpacking and inspection

5 Installation

- 5.1 Safety instructions
- 5.2 Selecting the installation location
- 5.3 Mounting the Inverter

6 Electrical connection

- 6.1 Safety
- 6.2 Wiring AC Output
- 6.3 Connecting the second protective conductor
- 6.4 Connecting the PV Array(DC input)
- 6.5 Connecting signal cable
- 6.6 Grounding the inverter
- 6.7 Active power control with smart meter , CT or ripple control signal receiver
- 6.8 Inverter demand response modes (DRMS)
- 6.9 AFCI(Optional)
- 6.10 Earth Fault Alarm

7 Commissioning

- 7.1 Start the inverter
- 7.2 General setting
- 7.3 Advanced setting
- 7.4 Communications

8 Start-Up and shut down the inverter

- 8.1 Start-Up the inverter
- 8.2 Shut down the Inverter

9 Maintenance ,Repair and Cleaning

- 9.1 Checking Heat Dissipation
- 9.2 Cleaning the Inverter
- 9.3 Checking the DC Isolator

10 EU Declaration of Conformity

11 Trouble shooting

- 11.1 Error Messages displayed on OLED
- 11.2 System fault
- 11.3 Inverter warning
- 11.4 Inverter fault

12 Manufacturer Warranty

13 Decommissioning

- 13.1 Dismantling the Inverter
- 13.2 Packing the Inverter
- 13.3 Storing the Inverter
- 13.4 Disposing of the Inverter

14 Technical Data

- 14.1 Specification
- 14.2 DC connector and Isolator info
- 14.3 Torque
- 14.4 Accessories

15 Compliance Certificates

16 Contact

1 Notes on this manual

1.1 Validity

This manual describes the assembly, installation, commissioning and maintenance of the following Growatt Inverter model:

MIN 7000 TL-X2
 MIN 8000 TL-X2
 MIN 9000 TL-X2
 MIN 10000 TL-X2

This manual does not cover any details concerning equipment connected to the MIN TL-X2(e.g. PV modules). Information concerning the connected equipment is available from the manufacturer of the equipment.

1.2 Target Group

This manual is for qualified personnel. Qualified personnel have received training and have demonstrated skills and knowledge in the construction and operation of this device. Qualified Personnel are trained to deal with the dangers and hazards involved in installing electric devices.



1.3 Additional information



Find further information on special topics in the download area at www.ginverter.com
 The manual and other documents must be stored in a convenient place and be available at all times. We assume no liability for any damage caused by failure to observe these instructions. For possible changes in this manual, GROWATT NEW ENERGY CO.,LTD accepts no responsibilities to inform the users.

1.4 Symbols in this document











1.4.1 Symbols in this document

A warning describes a hazard to equipment or personnel. It calls attention to a procedure or practice, which, if not correctly performed or adhered to, could result in damage to or destruction of part or all of the Growatt equipment and/or other equipment connected to the Growatt equipment or personal injury.

Symbol	description
 DANGER	DANGER indicates a hazardous situation which, if not avoided, will result in death or serious injury.
 WARNING	WARNING indicates a hazardous situation which, if not avoided, could result in death or serious injury.
 CAUTION	CAUTION indicates a hazardous situation which, if not avoided, could result in minor or moderate injury.

 NOTICE	NOTICE is used to address practices not related to personal injury.
 Information	Information that you must read and know to ensure optimal operation of the system.

1.4.2 Markings on this product

Symbol	Explanation
	Electrical voltage!
	Risk of fire or explosion !
	Risk of burns
	Operation after 5 minutes
	Point of connection for grounding protection
	Direct Current (DC)
	Isolation Switch
	Alternating Current (AC)
	Read the manual
	CE mark. The inverter complies with the requirements of the applicable CE guidelines.
	The inverter must not be disposed of with the household waste.

1.5 Glossary

AC
Abbreviation for "Alternating Current"

DC
Abbreviation for "Direct Current"

Energy
Energy is measured in Wh (watt hours), kWh (kilowatt hours) or MWh (megawatt hours). The energy is the power calculated over time. For example, your inverter operates at a constant power of 4600 W for half an hour and then at a constant power of 2300 W for another half an hour, it has fed 3450Wh of energy into the power distribution grid within that hour.

Power
Power is measured in W (watts), kW (kilowatts) or MW (megawatts). Power is an instantaneous value. It displays the power your inverter is currently feeding into the power distribution grid.

Power rate
Power rate is the ratio of current power feeding into the power distribution grid and the maximum power of the inverter that can feed into the power distribution grid.

Power factor
Power factor is the ratio of true power or watts to apparent power or volt amps. They are identical only when current and voltage are in phase than the power factor is 1.0. The power in an ac circuit is very seldom equal to the direct product of the volts and amperes. In order to find the power of a single phase ac circuit the product of volts and amperes must be multiplied by the power factor.

PV
Abbreviation for photovoltaic.

Wireless communication
The external wireless communication technology is a radio technology that allows the inverter and other communication products to communicate with each other. The external wireless communication does not require line of sight between the devices and it is selective purchasing.

2.1 Intended Use

The unit converts the DC current generated by the photovoltaic (PV) modules to grid-compliant alternating current and performs single-phase feed-in into the electricity grid. MIN 7000-10000TL-X2 inverters are built according to all required safety rules. Nevertheless, improper use may cause lethal hazards for the operator or third parties, or may result in damage to the units and other property.

Principle of a PV plant with this MIN TL-X2 single-phase inverter

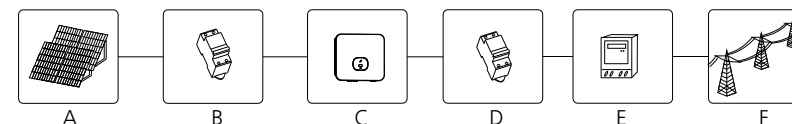

Fig 2.1

Position	Description
A	PV modules
B	DC load circuit breaker
C	Inverter
D	AC load circuit breaker
E	Energy meter
F	Utility grid

The inverter may only be operated with a permanent connection to the public power grid. The inverter is not intended for mobile use. Any other or additional use is not considered the intended use. The manufacturer/supplier is not liable for damage caused by such unintended use. Damage caused by such unintended use is at the sole risk of the operator.

PV modules Capacitive Discharge Currents

PV modules with large capacities relative to earth, such as thin-film PV modules with cells on a metallic substrate, may only be used if their coupling capacity does not exceed 1uF. During feed-in operation, a leakage current flows from the cells to earth, the size of which depends on the manner in which the PV modules are installed (e.g. foil on metal roof) and on the weather (rain, snow). This "normal" leakage current may not exceed 50mA due to the fact that the inverter would otherwise automatically disconnect from the electricity grid as a protective measure.



2.2 Qualification of skilled person

This grid-tied inverter system operates only when properly connected to the AC distribution network. Before connecting the MIN TL-X2 to the power distribution grid, contact the local power distribution grid company. This connection must be made only by qualified technical personnel to connect, and only after receiving appropriate approvals, as required by the local authority having jurisdiction.

2.3 Safety instruction

The MIN TL-X2 Inverters is designed and tested according to international safety requirements (IEC62109-1, CE, VDE0126-1-1, AS4777, etc) ; however, certain safety precautions must be observed when installing and operating this inverter. Read and follow all instructions, cautions and warnings in this installation manual. If questions arise, please contact Growatt's technical services at +86 (0)755 2747 1942.

2.4 Assembly Warnings



 <p>WARNING</p>	<ul style="list-style-type: none"> ➤ Prior to installation, inspect the unit to ensure absence of any transport or handling damage, which could affect insulation integrity or safety clearances; failure to do so could result in safety hazards. ➤ Assemble the inverter per the instructions in this manual. Use care when choosing installation location and adhere to specified cooling requirements. ➤ Unauthorized removal of necessary protections, improper use, incorrect installation and operation may lead to serious safety and shock hazards and/or equipment damage. ➤ In order to minimize the potential of a shock hazard due to hazardous voltages, cover the entire solar array with dark material prior to connecting the array to any equipment.
 <p>CAUTION</p>	<ul style="list-style-type: none"> ➤ Grounding the PV modules: The MIN TL-X2 is a transformerless inverter. That is why it has no galvanic separation. Do not ground the DC circuits of the PV modules connected to the MIN TL-X2. Only ground the mounting frame of the PV modules. If you connect grounded PV modules to the MIN TL-X2, the error message "PV ISO Low". ➤ Comply with the local requirements for grounding the PV modules and the PV generator. GROWATT recommends connecting the generator frame and other electrically conductive surfaces in a manner which ensures continuous conduction with ground in order to have optimal protection of the system and personnel.

2.5 Electrical Connection Warnings

 <p>DANGER</p>	<ul style="list-style-type: none"> ➤ The components in the inverter are live. Touching live components can result in serious injury or death. <ul style="list-style-type: none"> • Do not open the inverter except the wire box by qualified persons. • Electrical installation, repairs and conversions may only be carried out by electrically qualified persons. • Do not touch damaged inverters. ➤ Danger to life due to high voltages in the inverter <ul style="list-style-type: none"> • There is residual voltage in the inverter. The inverter takes 20 minutes to discharge. ➤ Persons with limited physical or mental abilities may only work with the Growatt inverter following proper instruction and under constant supervision. Children are forbidden to play with the Growatt inverter. Must keep the Growatt inverter away from children.
--	--

 <p>WARNING</p>	<ul style="list-style-type: none"> ➤ Make all electrical connections (e.g. conductor termination, fuses, PE connection, etc.) in accordance with prevailing regulations. When working with the inverter powered on, adhere to all prevailing safety regulations to minimize risk of accidents. ➤ Systems with inverters typically require additional control (e.g., switches, disconnects) or protective devices (e.g., fusing circuit breakers) depending upon the prevailing safety rules.
---	--

2.6 Operation Warnings

 <p>WARNING</p>	<ul style="list-style-type: none"> ➤ Ensure all connectors are sealed and secure during operation. ➤ Although designed to meet all safety requirements, some parts and surfaces of Inverter are still hot during operation. To reduce the risk of injury, do not touch the heat sink at the back of the PV-Inverter or nearby surfaces while Inverter is operating. ➤ Incorrect sizing of the PV plant may result in voltages being present which could destroy the inverter. The inverter display will read the error message "PV voltage High!" <ul style="list-style-type: none"> • Turn the rotary switch of the DC Disconnect to the Off position immediately. • Contact installer.
 <p>CAUTION</p>	<ul style="list-style-type: none"> ➤ All operations regarding transport, installation and start-up, including maintenance must be operated by qualified, trained personnel and in compliance with all prevailing codes and regulations. ➤ Anytime the inverter has been disconnected from the power network, use extreme caution as some components can retain charge sufficient to create a shock hazard; to minimize occurrence of such conditions, comply with all corresponding safety symbols and markings present on the unit and in this manual. ➤ In special cases, there may still be interference for the specified application area despite maintaining standardized emission limit values (e.g. when sensitive equipment is located at the setup location or when the setup location is near radio or television receivers). In this case, the operator is obliged to take proper action to rectify the situation. ➤ Do not stay closer than 20 cm to the inverter for any length of time.

3 Product description

3.1 TL-X2 Overview

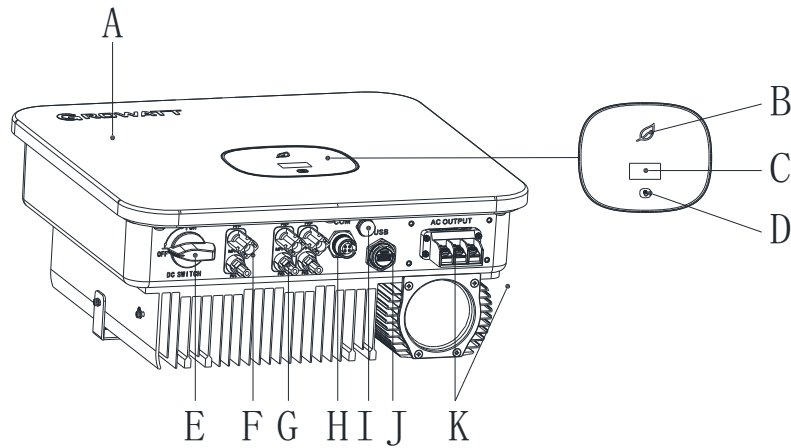

Fig 3.1

Position	Description
A	COVER
B	LED
C	OLED
D	TOUCH BUTTON
E	DC SWITCH
F	PV+ INPUT
G	PV- INPUT
H	COM PORT
I	VENTILATION VALVE
J	USB PORT
K	AC OUTPUT

Symbol on the inverter

Symbol	Description	Explanation																		
	Touch symbol	Touch button. We can switch the OLED display and set parameter by touching.																		
	Inverter status symbol	<table border="1"> <thead> <tr> <th>Inverter status</th> <th>LED color</th> <th>LED status</th> </tr> </thead> <tbody> <tr> <td>Standby</td> <td>Green</td> <td>0.5s on and 2s off</td> </tr> <tr> <td>Normal</td> <td>Green</td> <td>Solid</td> </tr> <tr> <td>Fault</td> <td>Red</td> <td>Solid</td> </tr> <tr> <td>Warning</td> <td>Green</td> <td>0.5s on, 0.5s off, 0.5s on, 2s off</td> </tr> <tr> <td>Programming</td> <td>Yellow</td> <td>1s on and 1s off</td> </tr> </tbody> </table>	Inverter status	LED color	LED status	Standby	Green	0.5s on and 2s off	Normal	Green	Solid	Fault	Red	Solid	Warning	Green	0.5s on, 0.5s off, 0.5s on, 2s off	Programming	Yellow	1s on and 1s off
		Inverter status	LED color	LED status																
		Standby	Green	0.5s on and 2s off																
		Normal	Green	Solid																
		Fault	Red	Solid																
Warning	Green	0.5s on, 0.5s off, 0.5s on, 2s off																		
Programming	Yellow	1s on and 1s off																		

3.2 Type label

The type labels provide a unique identification of the inverter (The type of product, Device-specific characteristics, Certificates and approvals). The type labels are on the left-hand side of the enclosure.

 PV Grid Inverter	
Model name	MIN 10000TL-X2
Max. PV voltage	600 d.c.V
PV voltage range	60-550 d.c.V
PV Isc	24 d.c.A *3
Max. input current	18 d.c.A *3
Max. output power	10 kW
Max. apparent power	10 kVA
Nominal output voltage	230 a.c.V
Max. output current	45.5 a.c.A
Nominal output frequency	50/60 Hz
Power factor range	0.8leading~0.8lagging
Safety level	Class I
Ingress protection	IP66
Operation ambient temperature	-30°C - +60°C
VDE0126-1-1 	
Made in China	

More detail about the type label as the chart below:

Model Name	MIN 7000 TL-X2	MIN 8000 TL-X2	MIN 9000 TL-X2	MIN 10000 TL-X2
Max input DC voltage	600V			
Max input DC current	18A/18A/18A			
Start voltage	80V			
MPP voltage range	60V~550V			
AC nominal voltage	220V/230V/240V			
AC grid frequency	50/60 Hz			
Max. apparent power	7000VA	8000VA	9000VA	10000VA
AC normal output current	31.8A	36.4A	40.9A	45.5A
Power factor	0.8leading...0.8lagging			
Environmental Protection Rating	IP 66			
Operation Ambienttemperature	-30...+60°C (-22...+ 140°F) with derating above 45°C (113°F)			

3.3 Size and weight

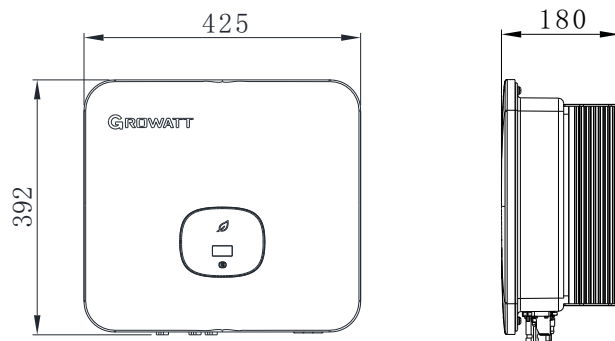

Fig 3.2

Dimensions and weight

Model	Height (H)	Width (W)	Depth (D)	Weight
MIN 7000-10000 TL-X2	425mm 16.7inch	392mm 15.4inch	180mm 7.1inch	18.2kg

3.4 Storage of Inverter

If you want to storage the inverter in your warehouse, you should choose an appropriate location to store the inverter.

- The unit must be stored in original package and desiccant must be left in the package.
- The storage temperature should be always between -30°C and +60°C. And the storage relative humidity can achieve to 100%.
- If there are a batch of inverters need to be stored, the maximum layers for original carton is four.
- After long term storage, local installer or service department of GROWATT should perform a comprehensive test before installation.

3.5 The advantage of the unit

- Maximum efficiency of 98.1%
- Wide input voltage range from 60--550Vdc
- Reactive power regulate
- Integrated DC switch
- Multi MPP controller
- DSP controller
- Touch control
- Multi active power control mode
- Easy installation

4 Unpacking and inspection

The inverter is thoroughly tested and inspected strictly before delivery. Our inverters leave our factory in proper electrical and mechanical condition. Special packaging ensures safe and careful transportation. However, transport damage may still occur. The shipping company is responsible in such cases. Thoroughly inspect the inverter upon delivery. Immediately notify the responsible shipping company if you discover any damage to the packaging which indicates that the inverter may have been damaged or if you discover any visible damage to the inverter. We will be glad to assist you, if required. When transporting the inverter, the original or equivalent packaging should be used, and the maximum layers for original carton is four, as this ensures safe transport.

After opening the package, please check the contents of the box. It should contain the following, Please check all of the accessories carefully in the carton. If anything missing, contact your dealer at once.

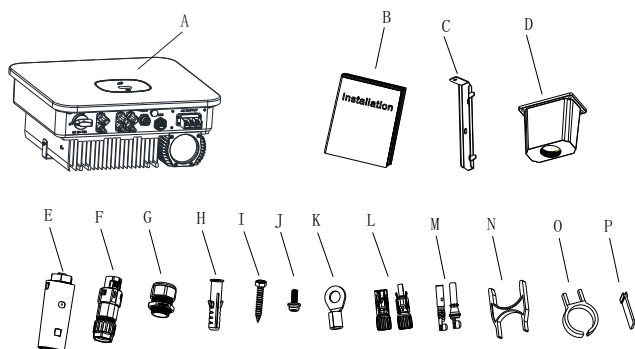

Fig 4.1

Object	Description	Quantity
A	Inverter	1
B	Quick Guide	1
C	Mounting bracket	1
D	AC waterproof cover	1
E	Monitor(Optional)	1
F	4PIN or 16PIN COM port signal connector	1
G	Waterproof connector	1
H	Plastic expansion tube	3
I	Self-tapping screw	3
J	Security screw	1
K	AC OT terminal	3
L	PV Male &Female cable coupler	3
M	PV Pin&Socket contacts	3
N	COM port removal tool	1
O	PV terminal removal tool	1
P	AC terminal block insulation partition	2

Installation 5

5.1 Safety instructions

	<p>Danger to life due to fire or explosion</p> <ul style="list-style-type: none"> ➤ Despite careful construction, electrical devices can cause fires. ➤ Do not install the inverter on easily flammable materials and where flammable materials are stored.
	<p>Risk of burns due to hot enclosure parts</p> <ul style="list-style-type: none"> ➤ Mount the inverter in such a way that it cannot be touched inadvertently.
	<p>Possible damage to health as a result of the effects of radiation!</p> <ul style="list-style-type: none"> ➤ In special cases, there may still be interference for the specified application area despite maintaining standardized emission limit values (e.g. when sensitive equipment is located at the setup location or when the setup location is near radio or television receivers). In this case, the operator is obliged to take proper action to rectify the situation. ➤ Never install the inverter near the sensitive equipment (e.g. Radios, telephone, television, etc) ➤ Do not stay closer than 20 cm to the inverter for any length of time unless it is absolutely necessary. ➤ Growatt assumes no responsibility for compliance to EMC regulations for the complete system

- All electrical installations shall be done in accordance with the local and national electrical codes. Do not remove the casing. Inverter contains no user serviceable parts. Refer servicing to qualified service personnel. All wiring and electrical installation should be conducted by a qualified service personnel.
- Carefully remove the unit from its packaging and inspect for external damage. If you find any imperfections, please contact your local dealer.
- Be sure that the inverters connect to the ground in order to protect property and personal safety.
- The inverter must only be operated with PV generator. Do not connect any other source of energy to it.
- Both AC and DC voltage sources are terminated inside the PV Inverter. Please disconnect these circuits before servicing.
- This unit is designed to feed power to the public power grid (utility) only. Do not connect this unit to an AC source or generator. Connecting Inverter to external devices could result in serious damage to your equipment.
- When a photovoltaic panel is exposed to light, it generates a DC voltage. When connected to this equipment, a photovoltaic panel will charge the DC link capacitors.
- Energy stored in this equipment's DC link capacitors presents a risk of electric shock. Even after the unit is disconnected from the grid and photovoltaic panels, high voltages may still exist inside the PV-Inverter. Do not remove the casing until at least 5 minutes after disconnecting all power sources.
- Although designed to meet all safety requirements, some parts and surfaces of Inverter are still hot during operation. To reduce the risk of injury, do not touch the heat sink at the back of the PV-Inverter or nearby surfaces while Inverter is operating.

5.2 Selecting the installation location

- This is guidance for installer to choose a suitable installation location, to avoid potential damages to device and operators.
- The installation location must be suitable for the inverter's weight and dimensions for a long period time.
- Select the installation location so that the status display can be easily viewed.
- Do not install the inverter on structures constructed of inflammable or thermolabile materials.
- Never install the inverter in environment of little or no air flow, nor dust environment. That may derate the efficiency of the cooling fan of the inverter.
- The Ingress Protection rate is IP66 which means the inverter can be installed outdoors and indoors.
- The humidity of the installation location should be 0~100% without condensation.
- The installation location must be freely and safely to get at all times.
- Vertically installation and make sure the connection of inverter must be downwards.
- Never install horizontal and avoids forward and sideways tilt.
- Multiple inverter combination is not suitable in Australia.

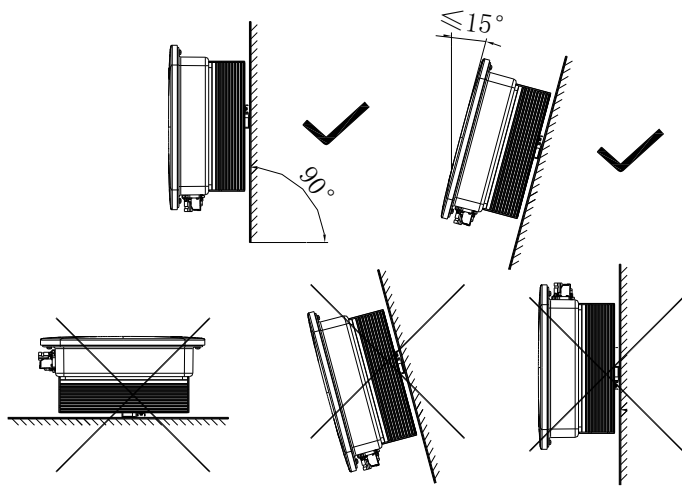

Fig 5.1

- Be sure that the inverter is out of the children's reach.
- Don't put any things on the inverter. Do not cover the inverter.
- Do not install the inverter near television antenna or any other antennas and antenna cables.
- Inverter requires adequate cooling space. Providing better ventilation for the inverter to ensure the heat escape adequately. The ambient temperature should be below 40°C to ensure optimum operation.
- Do not expose the inverter to direct sunlight, as this can cause excessive heating and thus power reduction.
- Observe the Min. clearances to walls, other inverters, or objects as shown below:

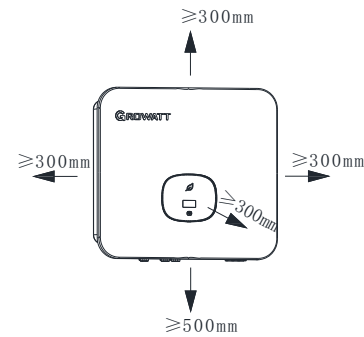

Fig 5.2

Ambient dimensions of one inverter

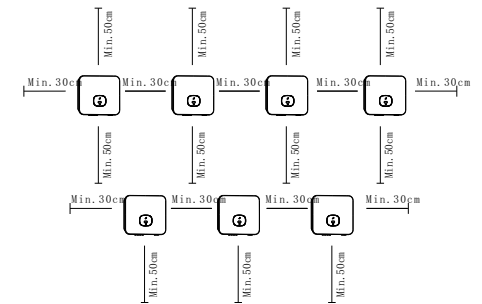

Fig 5.3

Ambient dimensions of series inverters

- There must be sufficient clearance between the individual inverters to ensure that the cooling air of the adjacent inverter is not taken in.
- If necessary, increase the clearance spaces and make sure there is enough fresh air supply to ensure sufficient cooling of the inverters.

The inverter can't install to solarization, drench, firm location. We suggest that the inverters should be installed at the location with some cover or protection.

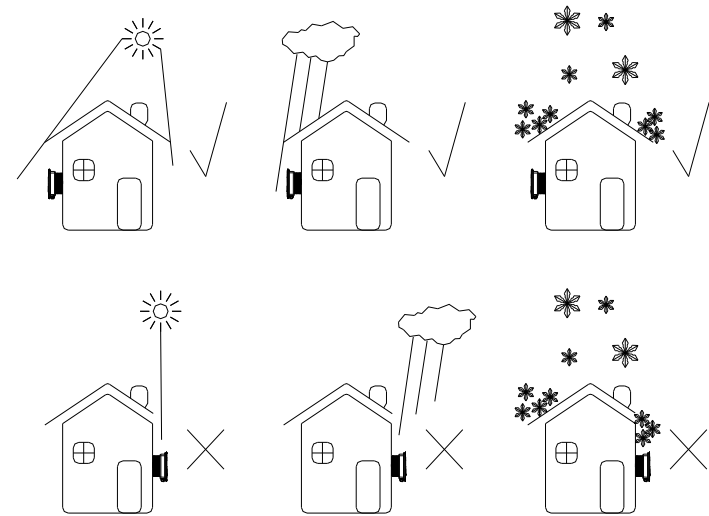

Fig 5.4

- Please make sure the inverter is installed at the right place. The inverter can't install close to trunk.

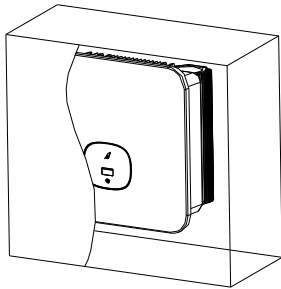

Fig 5.5

5.3 Mounting the Inverter

5.3.1 Mounting the Inverter with bracket



DANGER

In order to avoid electrical shock or other injury, inspect existing electronic or plumbing installations before drilling holes.

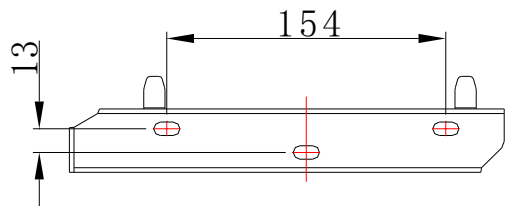

Fig 5.6

- Fix the mounting bracket as the figure shows. Do not make the screws to be flush to the wall. Instead, leave 2 to 4mm exposed.

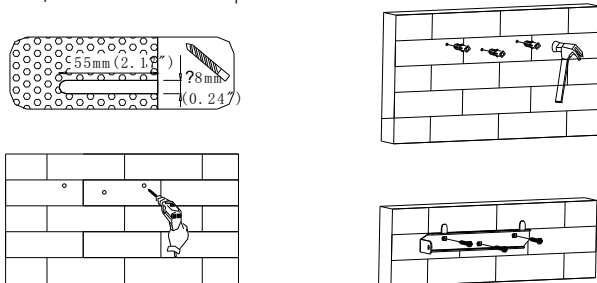

Fig 5.7

5.3.2 Fixed the inverter on the wall



WARNING

Falling equipment can cause serious or even fatal injury, never mount the inverter on the bracket unless you are sure that the mounting frame is really firmly mounted on the wall after carefully checking.

- Rise up the inverter a little higher than the bracket. Considered the weight of them. During the process please maintain the balance of the inverter.

Hang the inverter on the bracket through the match hooks on bracket.

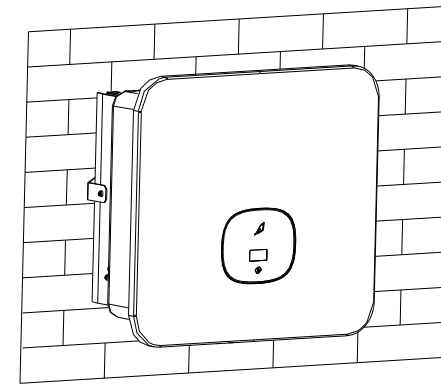

Fig 5.8

- After confirming the inverter is fixed reliably, fasten one M4 safety-lock screws on the right or left side firmly to prevent the inverter from being lifted off the bracket.

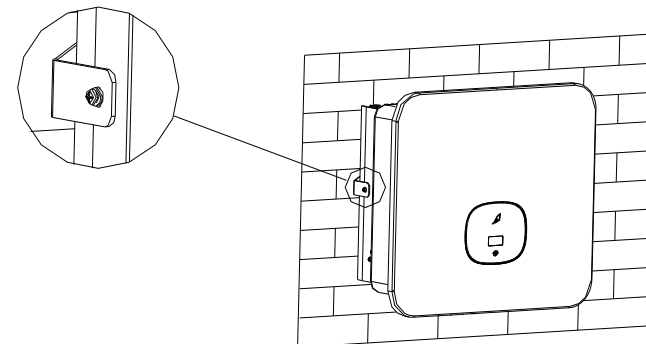



Fig 5.9

6 Electrical connection

Decisive Voltage Class (DVC) indicated for ports

Port Name	Class
AC	C
PV	C
DRM	A
RS485&USB	A

6.1 Safety

	<ul style="list-style-type: none"> ➤ Danger to life due to lethal voltages! ➤ High voltages which may cause electric shocks are present in the conductive parts of the inverter. Prior to performing any work on the inverter, disconnect the inverter on the AC and DC sides
 WARNING	<ul style="list-style-type: none"> ➤ Danger of damage to electronic components due to electrostatic discharge. Take appropriate ESD precautions when replacing and installing the inverter.

6.2 Wiring AC Output

 WARNING	<ul style="list-style-type: none"> ➤ You must install a separate single-phase circuit-breaker or other load disconnection unit for each inverter in order to ensure that the inverter can be safely disconnected under load. <p>NOTE :The inverter has the function of detecting residual current and protecting the inverter against residual current. If an external RCD breaker is mandatory in the country of installation, you must choose a Type A RCD breaker with the rating residual current not less than 300mA.</p>
--	--

You must install a separate single-phase circuit-breaker or other load disconnection unit for each inverter in order to ensure that the inverter can be safely disconnected under load.

We suggest you choice the AC breaker rating current in this table:

MIN 7000 TL-X2	50A/230V
MIN 8000 TL-X2	50A/230V
MIN 9000 TL-X2	63A/230V
MIN 10000 TL-X2	63A/230V

The AC wiring step:

1. Uninstall the parts of the AC connection plug from the accessory bag.
2. Pass the 3 wires (L or L1, N or L2 and PE wires) through the AC shield, connect them to the power grid, and then crimp the OT terminal.

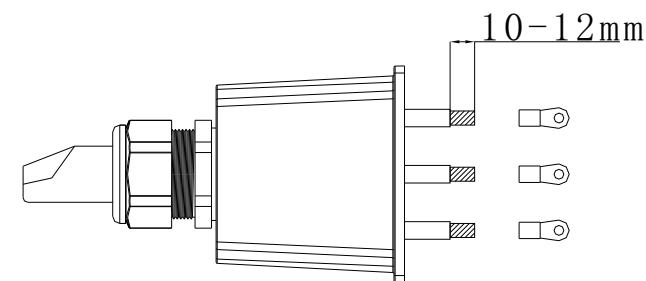

Fig 6.1

3. Lock the AC cable to the corresponding AC terminal.

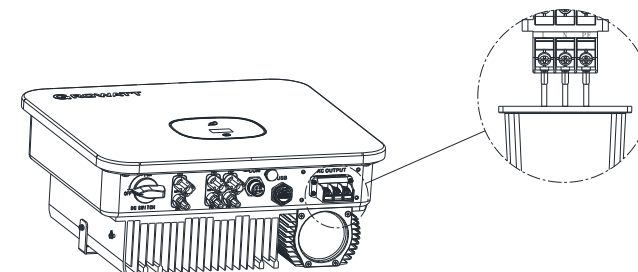

Fig 6.2

4. Insert two AC terminal block insulation partitions.

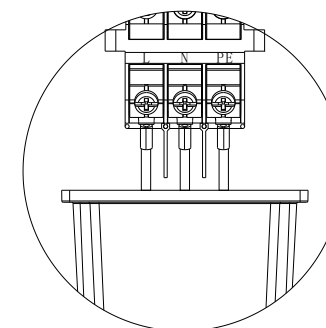

Fig 6.3

5. Finally, Lock the protective cover on the inverter frame, and finally tighten the protective cover hole.

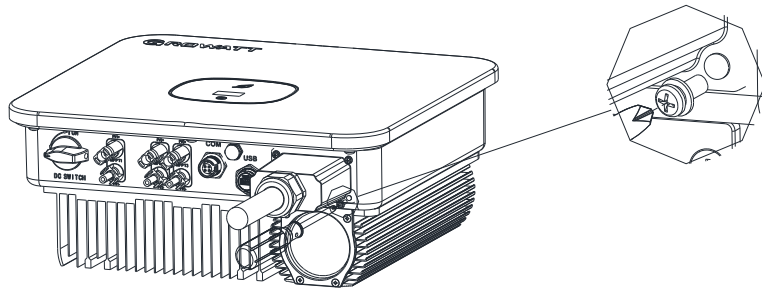

Fig 6.4

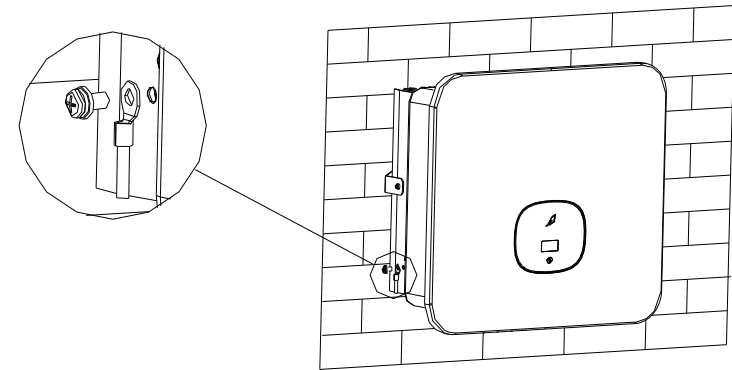

Fig 6.5

Wire suggestion length

Conductor cross section	Max. cable length			
	MIN 7000 TL-X2	MIN 8000 TL-X2	MIN 9000 TL-X2	MIN 10000 TL-X2
10AWG	42m	37m	33m	30m
9AWG	53m	47m	41m	37m
8AWG	67m	59m	52m	47m
7AWG	85m	74m	66m	59m
6AWG	107m	93m	83m	75m

6.3 Connecting the second protective conductor

In some installation countries, a second protective conductor is required to prevent a touch current in the event of a malfunction in the original protective conductor. For installation countries falling within the scope of validity of the IEC standard 62109, you must install the protective conductor on the AC terminal with a conductor cross-section of at least 10 mm²Cu. Or install a second protective conductor on the earth terminal with the same cross-section as the original protective conductor on the AC terminal. This prevents touch current if the original protective conductor fails.

6.4 Connecting the PV Array (DC input)

6.4.1 Conditions for DC Connection



WARNING

The solar modules connected to the inverter must conform to the Class A requirements of the IEC 61730 standard. Please use the same brand male and female PV connectors.

The MIN 7000-10000TL-X2 single-phase inverter has 3 independent input : MPPT1, MPPT2 & MPPT3.

Notice that the connectors are in paired (male and female connectors).

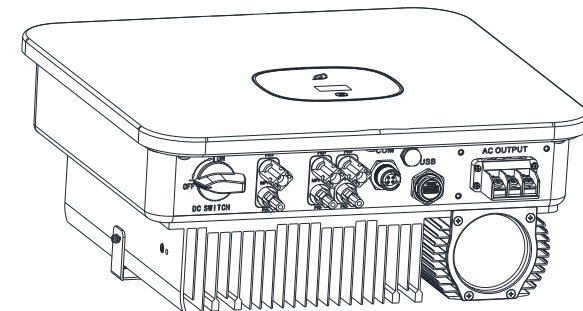





Fig 6.6

 CAUTION	If the inverter is not equipped with a DC switch but this is mandatory in the country of installation, install an external DC switch. The following limit values at the DC input of the inverter must not be exceeded:			
	Types	Max current MPPT1	Max current MPPT2	Max current MPPT3
	7000-10000 TL-X2	18A	18A	18A

6.4.2 Connecting the PV Array (DC input)

 DANGER	Danger to life due to lethal voltages! PV array supplies d.c voltage to inverter when exposed to light, before connecting the PV array, cover some light screens above PV arrays, ensure that the DC switch and AC breaker are disconnect from the inverter. NEVER connect or disconnect the DC connectors under load. Make sure the maximum open circuit voltage (Voc) of each PV string is less than the maximum input voltage of the inverter. Check the design of the PV plant. The Max. open circuit voltage, which can occur at solar panels temperature of -15°C, must not exceed the Max. input voltage of the inverter.
	 WARNING Improper operation during the wiring process can cause fatal injury to operator or unrecoverable damage to the inverter. Only qualified personnel can perform the wiring work. Please don't connect PV array positive or negative pole to the ground, it could cause serious damages to the inverter. Check the connection cables of the PV modules for correct polarity and make sure that the maximum input voltage of the inverter is not exceeded.

Connection of PV terminal

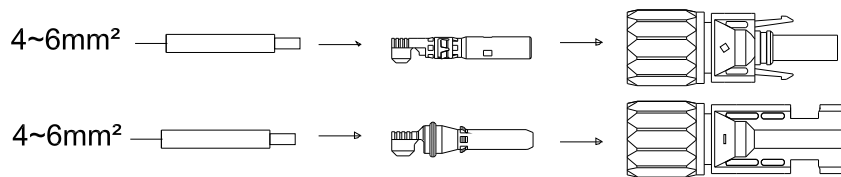

Fig 6.7

Make sure the cable polarity is correct and voltage is less than 550V.

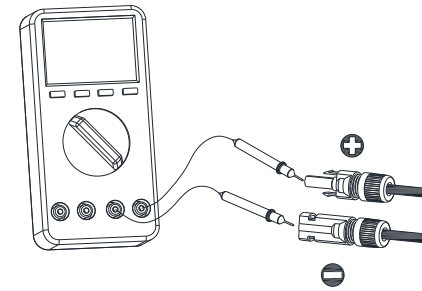

Fig 6.8

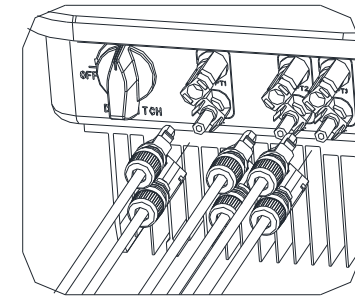

Fig 6.9

6.5 Connecting signal cable

This series inverter has one 4Pin or 16Pin signal terminal. Signal Port:

No.	Definition	
1	RS485A1	communication
2	RS 485B1	
3	RS485A2	RS485 for Smart Meter
4	RS 485B2	

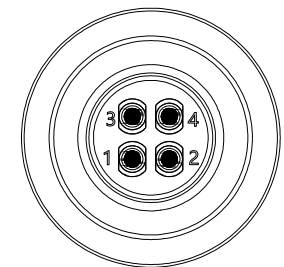

Fig 6.10

No.	Definition		No.	Definition		
1	+12V	Power supply for external relay($\leq 2W$)	9	DRM 5	DRMS	
2	COM		10	DRM 6		
3	RS 485A1	Signal for communication	11	DRM 7		
4	RS 485B1		12	DRM 8		
5	-	NC	13	RefGen		
6	-		14	Com/DRM0		
7	RS 485B2	Signal for Smart Meter	15	CT-P		Signal for export limitation
8	RS 485A2		16	CT-N		

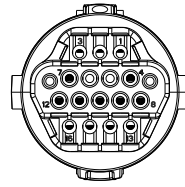

Fig 6.11

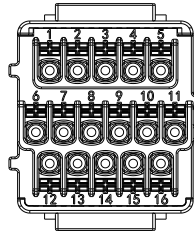

Fig 6.12

Procedure

Step 1 Insert the stripped and bared cable through pressure screw, seal ring, threaded sleeve in sequence, insert cables into connection terminal according to number indicates on it and tighten the screws firmly. Please try to pull out the wire to make sure the it's well connected.

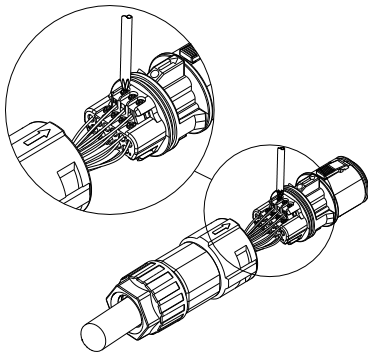

Fig 6.13

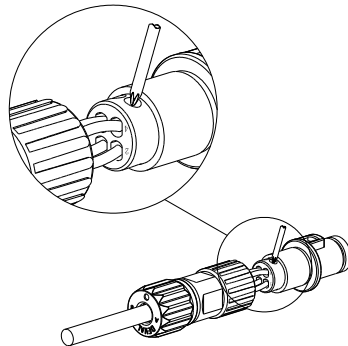

Fig 6.14

Step 2 Push the threaded sleeve into the socket, Tighten up the cap on the terminal.

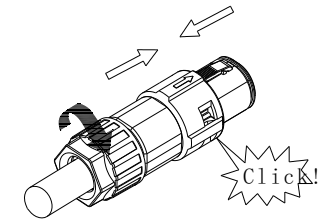

Fig 6.15

Step 3 Push the threaded sleeve to connection terminal until both are locked tightly on the inverter.

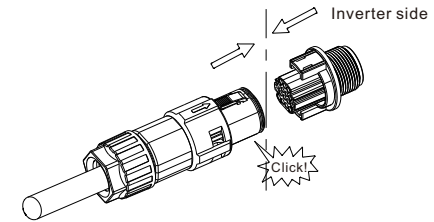

Fig 6.16

Uninstall signal connector

Step 1 Press the fasteners and pull it out from the inverter.

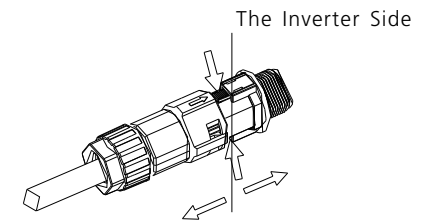

Fig 6.17

Step 2 Insert the H type tool and pull it out from the socket.

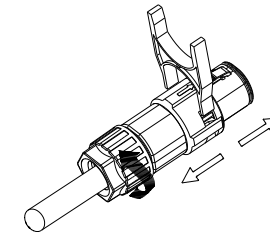

Fig 6.18

6.6 Grounding the inverter

The inverter must be connected to the AC grounding conductor of the power distribution grid via the ground terminal (PE) .



Because of the transformerless design, the DC positive pole and DC negative pole of PV arrays are not permitted to be grounded.

6.7 Active power control with smart meter , CT or ripple control signal receiver



Information

The position of export limitation CT or Meter must between the Inverter & Load and grid.
Multiple inverter combination is not suitable in Australia.

This series inverter has integrated generation limitation control and export limitation functionality.

The generation control function is used to control the active or apparent power output levels of an inverter.

The export limit control function for an inverter is used to control the generation from an inverter to manage the export power level from an electrical installation to the grid.

To use this function, you can connect smart meter or CT. The smart meter model is Eastron SDM120CT-M(40mA). The CT Model is ESC 16-100(ECHUN)/CTF16-2K5-100(Shenke) .The primary aperture is 10mm,output cable length is 5m . The arrow on the CT must pointing towards the inverter.The detailed information about the Meter,please refer to Annex -Eastron SDM120CT-M(40mA) user manual.

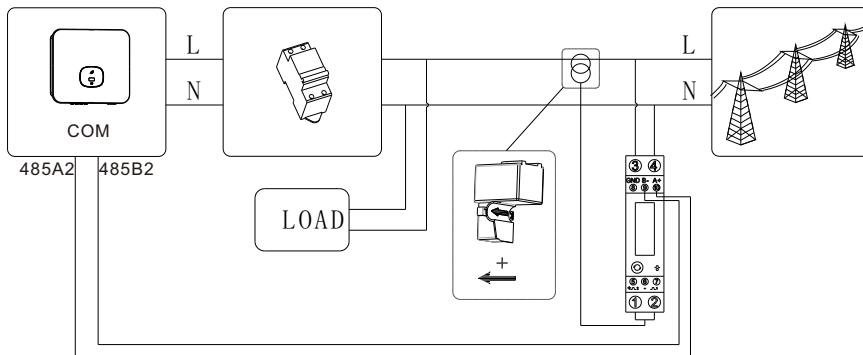

Fig 6.19

Manufacturer	Eastron
Type	SDM120CT-M(40mA)
General Specifications	
Voltage AC (Un)	230V
Voltage Range	176~276V AC
Base Current (Ib)	0.1V AC
Power consumption	<2W/10VA
Frequency	50/ 60Hz(±10%)
AC voltage withstand	4KV for 1 minute
Impulse voltage withstand	6KV-1.2uS waveform
Overcurrent withstand	20Imax for 0.5s
Pulse output 1	1000imp/kWh (default)
Pulse output 2	0.001(default) /0.01/0.1/1 kWh/kVArh (configurable)
Display Max. Reading	LCD with white backlit 999999kWh
Environment	
Operating temperature	-25°Cto +55°C
Storage and transportation temperature	-40°Cto +70°C
Reference temperature	23°Cto±AC
Relative humidity	0 to 95%, non-condensing
Altitude	up to 2000m
Warm up time	3s
Installation category	CAT II
Mechanical Environment	M1
Electromagnetic environment	E2
Degree of pollution	2
Mechanics	
Din rail dimensions	18x118x64 (WxHxD) DIN 43880
Mounting	DIN rail 35mm
Ingress protection	Ip51 (indoor)
Material	self-extinguishing UL94V-0

The following table describes how we can connect Eastron SDM 120CT-M(40mA):

Meter Pin NO.	Description	Meter Connection
1	CT-input	CT-P(White)
2		CT-N(Black or Blue)
3	N-in	Grid N
4	L-in	Grid L
9	RS485B	COM Port RS485B2
10	RS485A	COM Port RS485A2

Active power control with a ripple control signal receiver.

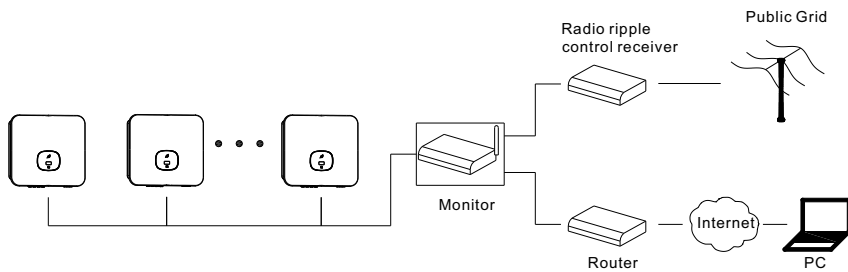



Fig 6.20

6.8 Inverter demand response modes (DRMS)

This series inverter has the function of demand response modes, We use 8Pin socket as inverter DRMS connection.

 Information	<p>DRMS application description</p> <ul style="list-style-type: none"> ➤ Only applicable to AS/NZS4777.2. ➤ DRM0, DRM5, DRM6, DRM7, DRM8 are available.
 CAUTION	<p>Damage to the inverter due to moisture and dust penetration</p> <ul style="list-style-type: none"> ➤ Make sure the cable gland has been tightened firmly. ➤ If the cable gland are not mounted properly, the inverter can be destroyed due to moisture and dust penetration. All the warranty claim will be invalid.

6.8.1 16Pin socket pin assignment

COM Socket Pin No.	Assignment for inverters capable of both charging and discharging
9	DRM 5
10	DRM 6
11	DRM 7
12	DRM 8
13	RefGen
14	Com/DRM0

6.8.2 Method of asserting demand response modes

Mode	Socket Asserted by shorting pins		Requirement
DRM 0	14	13	Operate the disconnection device
DRM 5	9	13	Do not generate power
DRM 6	10	13	Do not generate at more than 50% of rated power
DRM 7	11	13	Do not generate at more than 75% of rated power AND Sink reactive power if capable
DRM 8	12	13	Increase power generation (subject to constraints from other active DRMs)

6.8.3 Using DRMS for EU

 WARNING	Excessive voltage can damage the inverter! External voltage of DRMs PORT don't over +5V.
---	---

6.8.3.1 The following table describes the socket pin assignment and function:

COM Socket Pin NO.	Description	Connect to RRCR
9	Relay contact 1 input	K1 – Relay 1 output
10	Relay contact 2 input	K2 – Relay 2 output
11	Relay contact 3 input	K3 – Relay 3 output
12	Relay contact 4 input	K4 – Relay 4 output
13	GND	Relays common node
14	Not connected	Not connected

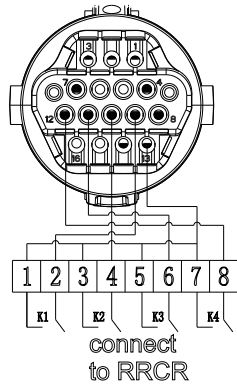

Fig 6.21

6.8.3.2 The inverter is preconfigured to the following RRRCR power levels:

COM Socket Pin9	COM Socket Pin10	COM Socket Pin11	COM Socket Pin12	Active power	Cos(φ)
Short circuit with Pin13				0%	1
	Short circuit with Pin13			30%	1
		Short circuit with Pin13		60%	1
			Short circuit with Pin13	100%	1

Active power control and reactive power control are enabled separately.

6.9 AFCI(Optional)

6.9.1 Arc-Fault Circuit Interrupter (AFCI)

In accordance with the National Electrical Code R, Article 690.11, the inverter has a system for the recognition of electric arc detection and interruption. An electric arc with a power of 300 W or greater must be interrupted by the AFCI within the time specified by UL 1699B. A tripped AFCI can only be reset manually. You can deactivate the automatic arc fault detection and interruption (AFCI) via a communication product in "Installer" mode if you do not require the function. The 2011 edition of the National Electrical Code R, Section 690.11 stipulates that newly installed PV systems attached to a building must be fitted with a means of detecting and disconnecting serial electric arcs (AFCI) on the PV side.

6.9.2 Danger information



Danger of fire from electric arc
Only test the AFCI for false tripping in the order described below.
Do not deactivate the AFCI permanently.

If an "Error 200" message is displayed, the buzzer alarms, an electric arc occurred in the PV system. The AFCI has tripped and the inverter is in permanent shutdown.

The inverter has large electrical potential differences between its conductors. Arc flashes can occur through air when high-voltage current flows. Do not work on the product during operation.

When the inverter error 200, please follow the steps:

6.9.3 Operation step

6.9.3.1 Turn the DC & AC Disconnect to position "OFF".

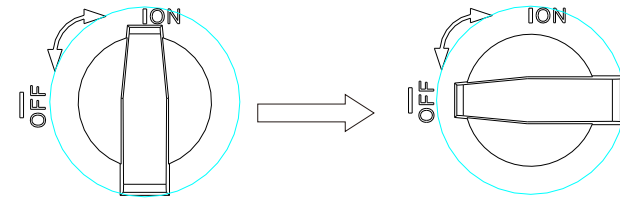

Fig 6.22

Wait for the display to go out.

6.9.3.2 Perform troubleshooting on the PV system:

Check all PV strings for the correct open-circuit voltage.

6.9.3.3 After the fault is rectified, restart the inverter:

Turn the DC & AC Disconnect to position "ON".

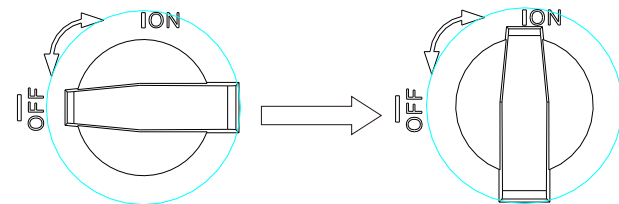





Fig 6.23

6.10 Earth Fault Alarm

The inverter complies with IEC62109-2. When the Earth fault occurs, the Red LED will light up. The buzzer in the inverter will keep ringing unless the fault condition is cleared (This function is only available for Australia and New Zealand).

7 Commissioning

 DANGER	Do not disconnect the DC connectors under load.
 WARNING	Improper operation during the wiring process can cause fatal injury to operator or unrecoverable damage to the inverter. Only qualified personnel can perform the wiring work.
 CAUTION	<p>Damage to the inverter due to moisture and dust penetration</p> <ul style="list-style-type: none"> ➤ Make sure the cable gland has been tightened firmly. ➤ If the cable gland are not mounted properly, the inverter can be destroyed due to moisture and dust penetration. All the warranty claim will be invalid.

Requirements :

- ✓ The AC cable is correctly connected.
- ✓ The DC cable is correctly connected.
- ✓ The communication cable is correctly connected.
- ✓ The country is set correctly.

7.1 Start the inverter

7.1.1 Touch control

Touch	Description
Single touch	Switch display or Number +1
Double touch	Enter
Three touch	Previous menu
Hold 5s	Confirm country setting or Number recover default value

7.1.2 Country/Area and Region setting

 Information	<p>Country/Area and Region setting</p> <p>When the inverter start up, we need to select the right country, if we don't select any country, the inverter will run under AS/NZS4777.2 as default for Australia & Region A, or run under VDE0126-1-1 for other region after 30s.</p>
---	--

When inverter powered on, OLED will light automatically. Once the PV power is sufficient, OLED displays the following:

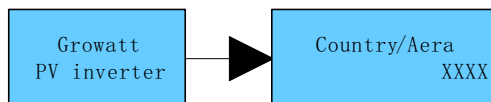

Fig 7.1

Press the touch key once a second to scroll through the different Country, showing on the screen will constantly change. For example, if you want to choose Newzealand, press the control key until the OLED display shows "Newzealand" as below:



Fig 7.2

Press the touch key 5S, the OLED shows Country setting is complete.

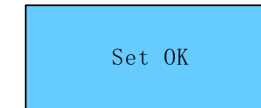

Fig 7.3

When the Country setting is complete (Only for Australia), the OLED display shows "Set Region" as below:

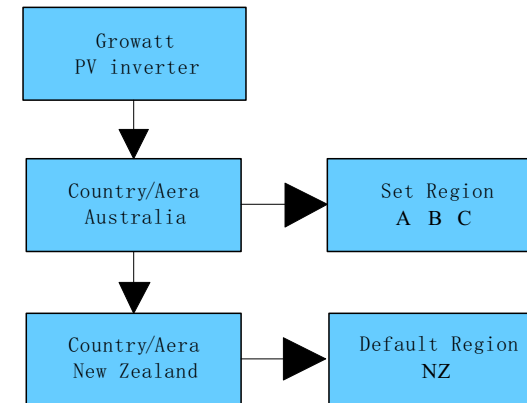



Fig 7.4

The installer must set Region A, B or C when you choose Australia, but if you choose Newzealand the default Region is NZ. When Region A is selected, the inverter loads all the Region A values for power quality response modes and grid protection settings.

7.1.3 Enabling/Disabling Power Quality Response Modes (PQR)

 Information	<p>PQR setting</p> <p>When the Region setting is completed, the inverter will operate under default mode different from region.</p>
---	--

MIN TL-X2 contains five types Power Quality Response Modes: Volt-Var, Volt-watt, Fixed PF, Reactive power, Power limit. If you want to change the Power Quality Response Modes please refer to chapter 7.3.1.

7.1.4 Check firmware version, Region, Country/Area and Power Quality Response Modes.

Single touch to switch display.
Double touch to enter next stage menu.

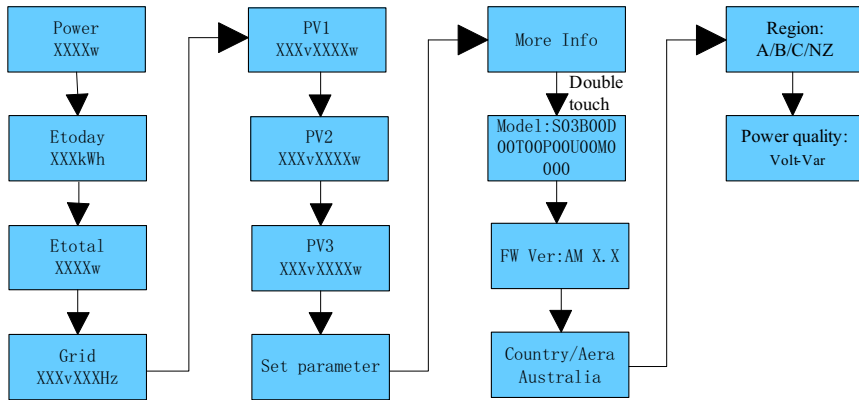

Fig 7.5

7.2 General Setting

7.2.1 Set inverter display language

This series inverter provides multi languages. Single touch to switch different language. Double touch to confirm you setting. Set the language as described below:

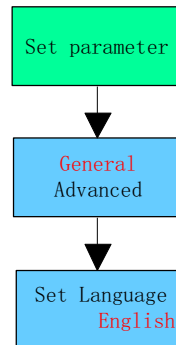

Fig 7.6

7.2.2 Set inverter COM address

The default COM address is 1. We can change COM address as described below: Single touch to switch display or make the number +1. Hold 5s, the COM address become 001. Double touch to confirm you setting.

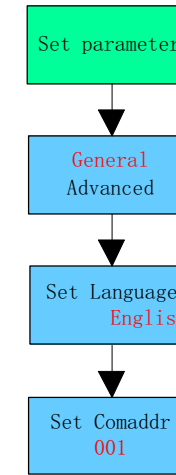

Fig 7.7

7.2.3 Set inverter date & time

Single touch make the number +1. Double touch to confirm you setting. Hold 5s recover default value.

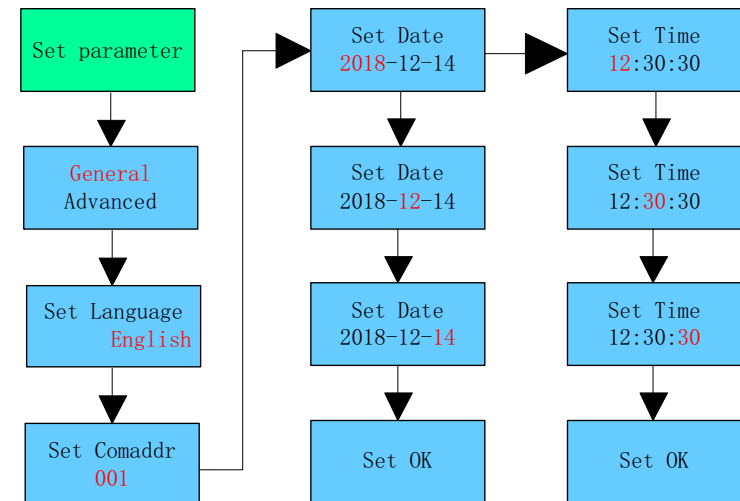

Fig 7.8

7.3 Advanced setting

7.3.1 Reset Country, Region and Power Quality Response Modes (PQRM)

Single touch to switch display or make the number +1.
 Double touch to confirm you setting.
 Input right password, you can change regional settings.

Reset Country

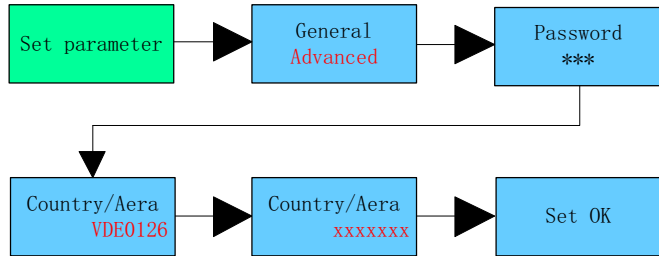

Fig 7.9

Reset Region

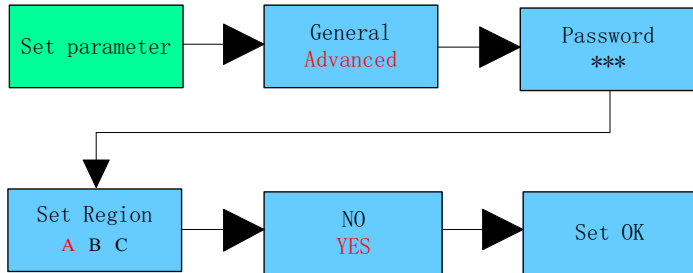

Fig 7.10

Reset PQRM

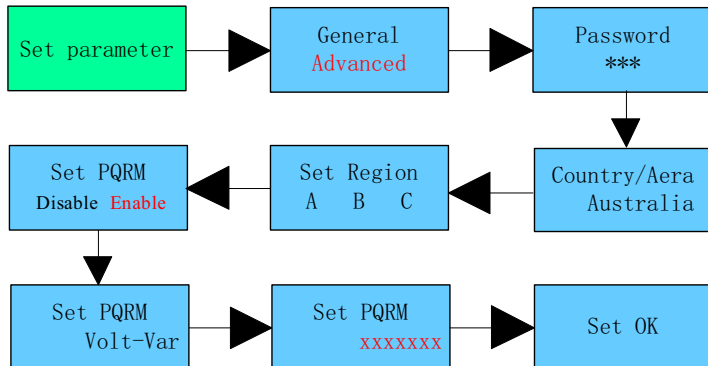

Fig 7.11

7.3.2 Generation & Export limitation control and Power Sensor setting

Single touch to switch display or make the number +1.

Double touch to confirm you setting.

Control type:

SW stands for enabling software limit control function

HW stands for enabling hardware limit control function

Both stands for enabling software and hardware limit control function at the same time.

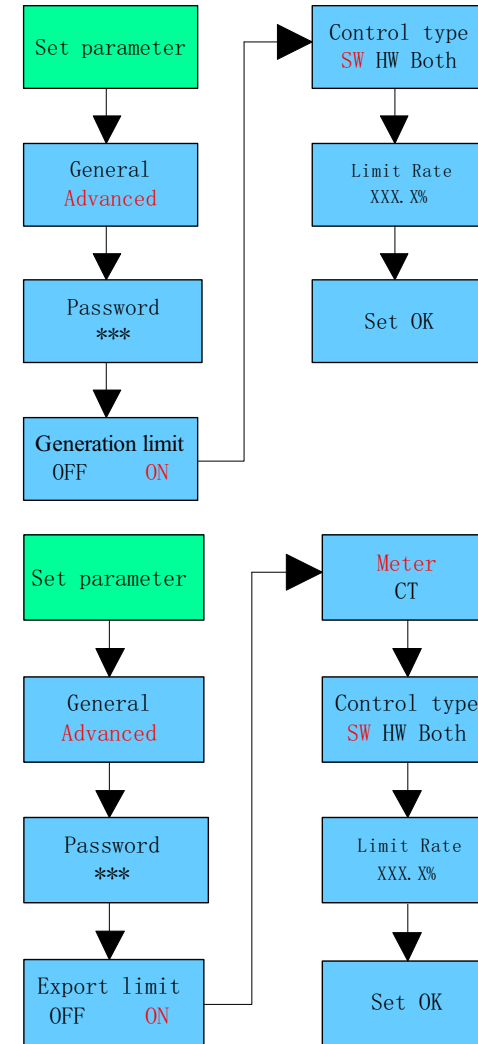

Fig 7.12

Under the permission given by your energy provider, the ratio of your system output power divided by the rated power of the inverter is called Limit Rate. For instance, if the energy provider only accepts 8kVA/kW from your 10kW system, then the Limit Rate of 10kW inverter is 80.0%.

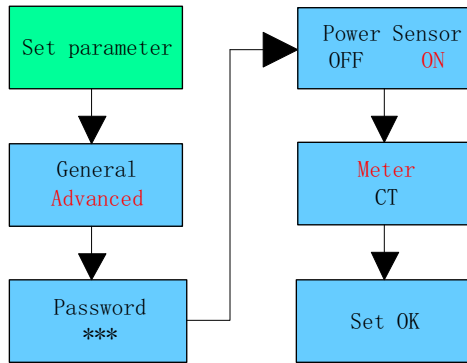

Fig 7.13

If you only want to check the load consumption function, you can choose Meter as Power sensor. CT is just only for Export Limit function.

7.3.3 Reset factory

i

Perform this operation with caution because all configured parameters except the current date, time, and model parameters will be restored to their factory defaults.

Single touch to switch display or make the number +1.
Double touch to confirm you setting.

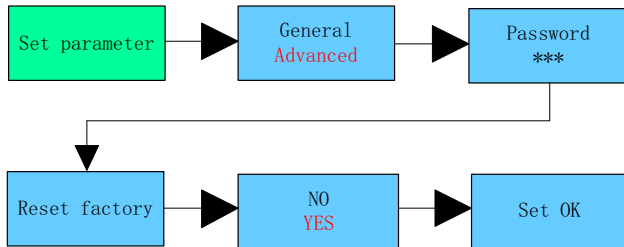

Fig 7.14

7.3.4 Adjust the setpoints from the regional default values

Under the permission by Distribution Network Service Provider, the installer can adjust the setpoints from the regional default values. Please refer to the document 《Adjust the setpoints from the regional default values instruction》

7.4 Communications

7.4.1 RS485

This series inverter has one 4Pin or 16Pin signal socket. The inverter provides two RS485 ports. You can monitor one or more inverters by RS485. Another RS485 port is for smart meter (Export limitation functionality).

4Pin socket pin assignment

No.	Definition	
1	RS485A1	communication
2	RS 485B1	
3	RS485A2	Rs485 for Smart Meter
4	RS 485B2	

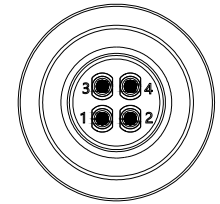

Fig 7.15

16Pin socket pin assignment

No.	Definition		No.	Definition		
1	+12V	Power supply for external relay(≤2W)	9	DRM 5	DRMS	
2	COM		10	DRM 6		
3	RS 485A1	RS485 for communication	11	DRM 7		
4	RS 485B1		12	DRM 8		
5	-	NC	13	RefGen		
6	-		14	Com/DRM0		
7	RS 485B2	RS485 for Smart Meter	15	CT-P		Signal for CT export limitation (optional*)
8	RS 485A2		16	CT-N		

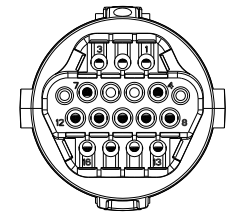

Fig 7.16

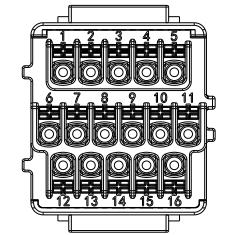

Fig 7.17

* Only for Australia market.

7.4.2 USB-A

USB-A port is mainly for connecting monitor or firmware update. Through USB connection, we can connect external optional monitor, for example: Shine WIFI-X, Shine 4G-X, Shine LAN-X, ect.

And also you can quickly update the software by U stick.

We can monitor as below:

Make sure the Δ on the front side, then insert the monitor, fasten the screw.

Maintenance, Repair and Cleaning 9

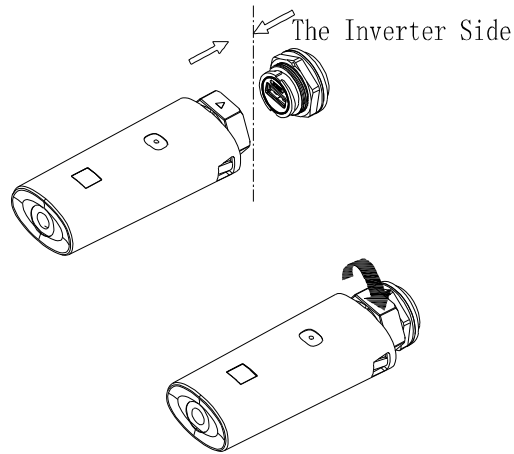



Fig 7.18

8 Start-up and shut down the Inverter

8.1 Start-Up the inverter

1. Connect the AC breaker of the inverter.
2. Turn on the dc switch, and the inverter will start automatically when the input voltage is higher than 60 V.

8.2 Shut down the Inverter

 DANGER	Do not disconnect the DC connectors under load.
---	---

Turn-off the inverter step:

1. Disconnect the line circuit breaker from single-phases grid and prevent it from being reactivated.
2. Turn off the dc switch.
3. Check the inverter operating status.
4. Waiting until LED, OLED have go out, the inverter is shut down.

 WARNING	Prior to removal of any cover for maintenance or repair, turn off the switch on the AC and DC sides
--	---

9.1 Checking Heat Dissipation

If the inverter regularly reduces its output power due to high temperature, please improve the heat dissipation condition. Maybe you need to clean the heat sink.

9.2 Cleaning the Inverter

If the inverter is dirty, turn-off the AC breaker and DC switch, waiting the inverter shut down, then clean the enclosure lid, the display, and the LEDs using only a wet cloth. Do not use any cleaning agents (e.g. solvents or abrasives).

9.3 Checking the DC Isolator

Check for externally visible damage and discoloration of the DC Isolator and the cables at regular intervals. If there is any visible damage to the DC Isolator, or visible discoloration or damage to the cables, contact the installer.

- Once a year, turn the rotary switch of the DC Isolator from the On position to the Off position 5 times in succession. This cleans the contacts of the rotary switch and prolongs the electrical endurance of the DC Isolator.

10 EU Declaration of Conformity

With the scope of EU directives:

- 2014/35/EU Low Voltage Directive (LVD)
- 2014/30/EU Electromagnetic Compatibility Directive (EMC)
- 2011/65/EU RoHS Directive and its amendment (EU)2015/863

Shenzhen Growatt New Energy Co. Ltd confirms that the Growatt inverters and accessories described in this document are in compliance with the above mentioned

EU directives. The entire EU Declaration of Conformity can be found at www.ginverter.com.

Trouble shooting 11

Our quality control program assures that every inverter is manufactured to accurate specifications and is thoroughly tested before leaving our factory. If you have difficulty in the operation of your inverter, please read through the following information to correct the problem.

11.1 Error Messages displayed on OLED

An error message will be displayed on the OLED screen when a fault occurs. The faults consist of system fault and inverter fault.

You may be advised to contact Growatt in some situation, please provide the following information.

Information concerning the inverter:

- Serial number
- Model number
- Error message on OLED
- Short description of the problem
- Grid voltage
- DC input voltage
- Can you reproduce the failure? If yes, how?
- Has this problem occurred in the past?
- What was the ambient condition when the problem occurred?

Information concerning the PV panels:

- Manufacturer name and model number of the PV panel
- Output power of the panel
- Voc of the panel
- Vmp of the panel
- Imp of the panel
- Number of panels in each string

If it is necessary to replace the unit, please ship it in the original box.

11.2 System fault

System fault (system faults are mainly caused by system instead of inverter, please check the items as instructed below before replacing inverter).

Error message	Description	Suggestion
AFCI fault Error: 200	There is a high power discharge of electricity between two or more conductors	1.After shut down the inverter,check the connection of PV terminals. 2.Restart the inverter. 3.If error message still exists,contact Growatt.
Residual I High Error: 201	Leakage current too high	1.Restart the invert. 2.If error message still exists,contact Growatt.
PV Voltage High Error: 202	The DC input voltage is exceeding the maximum tolerable value	1.Disconnect the DC switch immediately. 2. Check the voltage of each PV string with multimeter. 3.If the voltage of PV string is lower than , contact Growatt.

Error message	Description	Suggestion
PV Isolation Low Error: 203	Insulation problem	1. Check if panel enclosure ground properly. 2. Check if inverter ground properly. 3. Check if the DC breaker gets wet. 4. Check the impedance of PV (+) & PV (-) between ground (must be more than 30 K Ω). If the error message is displayed despite the above checking passed, contact Growatt.
Residual I High Error: 201	Leakage current too high	1. Restart the invert. 2. If error message still exists, contact Growatt.
PV Voltage High Error: 202	The DC input voltage is exceeding the maximum tolerable value	1. Disconnect the DC switch immediately. 2. Check the voltage of each PV string with multimeter. 3. If the voltage of PV string is lower than , contact Growatt.
AC V Outrange Error: 300	Utility grid voltage is out of permissible range	1. Please switch off DC switch. 2. Check AC wiring, especially neutral and ground wire. 3. Check grid voltage is complied with local grid standard. Restart inverter, if problem still exist, contact Growatt.
No AC connection Error: 302	No AC connection	1. Check AC wiring. 2. Check the status of AC breaker.
PE abnormal Error: 303	Voltage of Neutral and PE above 30V	1. Check the voltage of Neutral and PE. 2. Check AC wiring. 3. Restart inverter, if error message still exists, contact Manufacturer.
AC F Outrange Error: 304	Utility grid frequency out of permissible range	1. Please switch off DC switch. 2. Check AC wiring, especially neutral and ground wire. 3. Check grid frequency is complied with local grid standard. 4. Restart inverter, if problem still exist, contact Growatt.
Auto Test Failed Error: 407	Auto test didn't pass	Restart inverter, repeat Auto Test, if problem still exist, contact Growatt.

11.3 Inverter warning

Warning code	Meanings	Suggestion
Warning 202	DC SPD function abnormal	1. After shutdown, Check the DC SPD. 2. If error message still exists, contact manufacturer.
Warning 203	PV1, PV2 or PV3 Circuit short	1. Check the PV panel polarity. 2. Restart the inverter. If the warning still exist, please contact Growatt customer service to replace the POWER board.
Warning 204	Dryconnect function abnormal	1. After shutdown, Check the dry Dryconnect wiring. 2. If the error message still exists, contact manufacturer.
Warning 205	PV1, PV2 or PV3 boost broken	Restart the inverter. If the warning still exist, please contact Growatt customer service to replace the power board.
Warning 207	USB over-current	1. Unplug the U stick or monitor. 2. Re-access U stick or monitor after shutdown. 3. If the error message still exists, contact manufacturer.
Warning 401	Inverter communicates with Meter abnormal	1. Check if the meter is on. 2. Check the inverter and the meter connection is normal .
Warning 404	EEPROM abnormal	Restart the inverter. If the warning still exist, please contact Growatt customer service to replace the M3 board.
Warning 405	Firmware version is not consistent	Update the right version firmware

Manufacturer Warranty 12

Please refer to the warranty card.

11.4 Inverter fault

Error code	Meanings	Suggestion
Error: 402	Output High DCI	Restart inverter, if problem still exist, Contact Growatt.
Error: 404	Bus sample fault	Restart inverter, if problem still exist, Contact Growatt.
Error: 405	Relay fault	Restart inverter, if problem still exist, Contact Growatt.
Error: 408	Over Temperature	If the ambient temperature of inverter is lower than 60°C, restart inverter, if error message still exists, contact Growatt.
Error: 409	Bus over voltage	Restart inverter, if problem still exist, Contact Growatt.
Error: 411	DSP communicates with M3 abnormal	1.Restart inverter, if problem still exist, contact Growatt. 2.hange DSP board or M3 board, if problem still exist, contact Growatt.
Error: 414	EEPROM fault	Restart inverter, if problem still exist, Contact Growatt.
Error: 416	Over current protected by software	Restart inverter, if problem still exist, Contact Growatt.
Error: 420	GFCI fault	Restart inverter, if problem still exist, change power board, or contact Growatt.
Error: 422	The data sampled by the DSP and redundant M3 is not the same	Restart inverter, if problem still exist, Contact Growatt.
Error: 425	AFCI self-test fault	Restart inverter, if problem still exist, or contact Growatt.

Decommissioning 13

13.1 Dismantling the Inverter

1. Disconnect the inverter as described in section 8.
2. Remove all connection cables from the inverter.



Danger of burn injuries due to hot enclosure parts!
Wait 20 minutes before disassembling until the housing has cooled down.

3. Screw off all projecting cable glands.
4. Lift the inverter off the bracket and unscrew the bracket screws.

13.2 Packing the Inverter

If possible, always pack the inverter in its original carton and secure it with tension belts. If it is no longer available, you can also use an equivalent carton. The box must be capable of being closed completely and made to support both the weight and the size of the inverter.

13.3 Storing the Inverter

Store the inverter in a dry place where ambient temperatures are always between -30°C and +60°C.

13.4 Disposing of the Inverter



Do not dispose of faulty inverters or accessories together with household waste. Please accordance with the disposal regulations for electronic waste which apply at the installation site at that time. Ensure that the old unit and, where applicable, any accessories are disposed of in a proper manner.

14 Technical Data

14.1 Specification

Model	7000TL-X2	8000TL-X2	9000TL-X2	10000TL-X2
Specifications				
Input data(DC)				
Max. recommended PV power(for module STC)	12k	12k	13.5k	15k
Max. DC voltage	600V			
Start voltage	80V			
Min. operating voltage	60V			
Nominal voltage	360V			
MPP voltage range	60-550			
No. of MPP trackers	3			
No. of PV strings per MPP trackers	1/1/1			
Max. input current per MPP trackers	18/18/18A			
Max. short-circuit current per MPP trackers	24/24/24A			
Output data(AC)				
Rated output power	7000W	8000W	9000W	10000W
Rated apparent power	7000VA	8000VA	9000VA	10000VA
Max. apparent power	7000VA	8000VA	9000VA	10000VA
Nominal AC voltage/range**	220/230/240V/160 ~ 300V			
AC grid frequency/range**	50-60Hz/44-55Hz;54-65Hz			
Rated output current	31.8A	36.4A	40.9A	45.5A
Max. output current	33.5A	38.3A	43A	47.7A
Max output overload protection	50A	50A	63A	63A
Max. inrush current (Peak value/duration time)	<10A/5ms			
Max. output fault current (Peak value/duration time)	<108A/10us			
Max. inverter backfeed current to PV array	0A			
Power factor(@nominal power)	>0.99			

Model	7000TL-X2	8000TL-X2	9000TL-X2	10000TL-X2
Specifications				
Adjustable power factor	0.8leading...0.8lagging			
THDi	<3%			
AC grid connection type	Single phase			
Overvoltage category	PV:II AC:III Others:I			
Efficiency				
Max. efficiency	98.1%			
Euro-eta	97.5%			
Protection devices				
DC reverse-polarity protection	Integrated			
DC switch	Integrated			
DC Surge protection	Type II			
AFCI	Optional			
Insulation resistance monitoring	Integrated			
AC surge protection	Type III			
AC short-circuit protection	Integrated			
Ground fault monitoring	Integrated			
Grid monitoring	Integrated			
Anti-islanding protection	Integrated (Active Frequency Drift)			
Residual-current monitoring unit	Integrated			
General data				
Dimensions (W / H / D) in mm	425/387/180			
Weight	18.2kg			
Operating temperature range	-30 °C ... +60 °C			
Noise emission (typical)	≤ 25 dB(A)			
Altitude	4000m			
Internal consumption at night***	<1W			
Topology	Non-isolated			

Model	7000TL-X2	8000TL-X2	9000TL-X2	10000TL-X2
Specifications				
Cooling	Natural convection			
Protection degree	IP66			
Relative humidity	0~100%			
DC connection	H4/MC4(Optional)			
AC connection	Cable gland +OT terminal			
Interfaces				
Display	OLED+LED			
RS485/USB	Integrated			
WIFI/GPRS/4G/LAN/RF	Optional			
Warranty:5/10 years	Yes/ Optional			

*Only for Australia market.

**The AC Voltage and Frequency Range may vary depending on specific country grid standard.

***Without AC power supply function.

All specifications are subject to change without notice.

14.2 DC connector and Isolator info

DC connector	VP-D4/ MC4(opt)
Isolator*	NDG3V-50
Rated insulation voltage	1500V
Rated impulse withstand voltage	8kV
Suitability for isolation	Yes
Rating thermal current(Ith)	63A
Rated operational current(Ie)	55A
Utilization category and/or PV utilization category	DC-21B/PV2
Rated short time withstand current (Icw)	700A
Rated short-circuit making capacity (Icm)	1.4kA
Rated breaking capacity	220A

*Only for Australia market.

14.3 Torque

Enclosure lid screws	12kgf.cm
AC terminal	6kgf.cm
Signal terminal	4kgf.cm
Safety screw	12kgf.cm
Additional ground screws	12kgf.cm

14.4 Accessories

In the following table you will find the optional accessories for your product. If required, you can order these from GROWATT NEW ENERGY CO.,LTD or your dealer.

Name	Brief description
Shine WIFI-X	WIFI monitor with USB interface
Shine 4G-X	4G monitor with USB interface
Shine Link-X	RF monitor with USB interface
Shine LAN-X	LAN monitor with USB interface

Shipped to a Growatt service centre for repair, or repaired on-site, or exchanged for a replacement device of equivalent value according to model and age.

The warranty shall not cover transportation costs in connection with the return of defective modules. The cost of the installation or reinstallation of the modules shall also be expressly excluded as are all other related logistical and process costs incurred by all parties in relation to this warranty claim.

15 Compliance Certificates

•Certificates

With the appropriate settings, the unit will comply with the requirements specified in the following standards and directives :

Model	Certificates
7000-10000TL-X2	CE , IEC 62109, AS4777,UL1741,ABNT NBR 16149

16 Contact

If you have technical problems about our products, contact the GROWATT Serviceline.
We need the following information in order to provide you with the necessary assistance:

- Inverter type
- Serial number of the inverter
- Event number or display message of the inverter
- Type and number of PV modules connected
- Optional equipment

Shenzhen Growatt New Energy Co., Ltd

4-13/F, Building A,Sino-German (Europe) Industrial Park,
Hangcheng Ave,Bao'an District, Shenzhen, China

T +86 0755 2747 1942

E service@ginverter.com

W www.ginverter.com