

Quick Installation Manual
APX 5.0~30.0P-S1

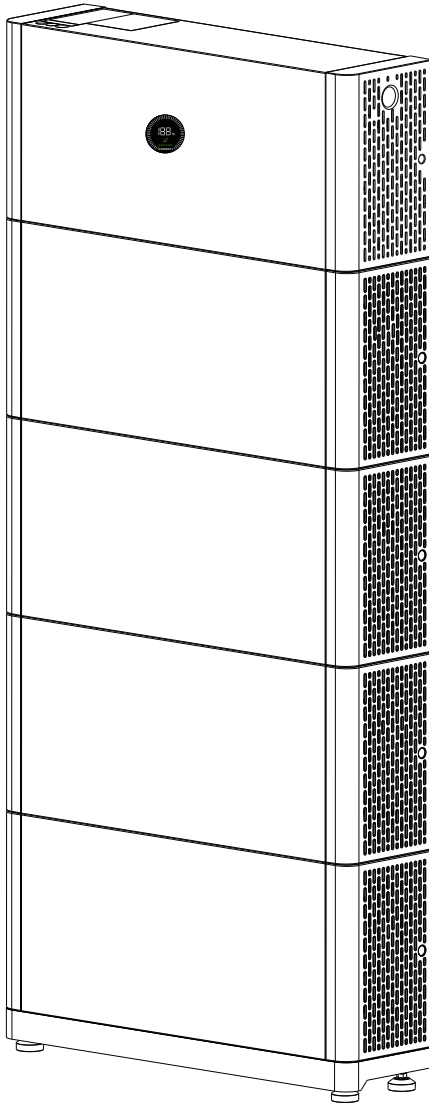

Environment requirements



Max.+50°C



Min.-10°C



RH + 5%~+95%

Installation tools

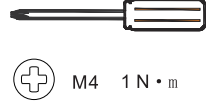
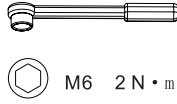
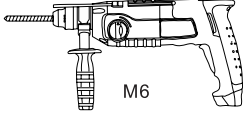

Dimensions

Unit:mm

APX 98020-P1
(Power Module)

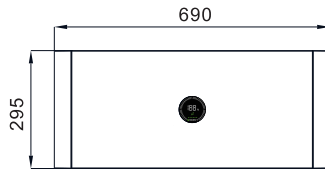

APX 5.0P-B1
(Battery Module)

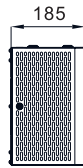
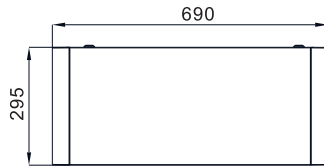

1. Inspection upon delivery

1-1 Checking the APX 98020-P1 packing list

Please check that the contents are complete

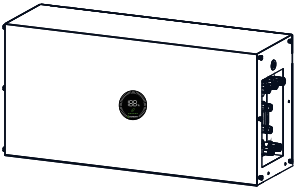

APX 98020-P1 (PM)

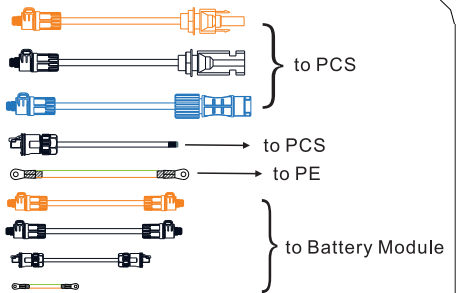

System cable

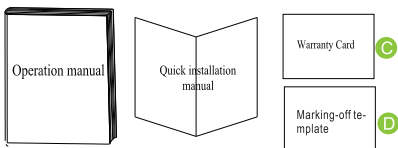

- A** Operation Manual *1
- B** Quick installation manual *1
- C** Warranty Card *1
- D** Marking-off template *1

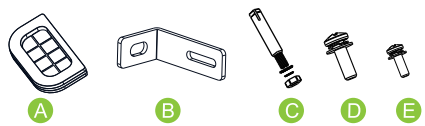

- A** Protective rubber ring *4
- B** Anti-tipping plate *2
- C** M6 expansion screw *2
- D** M6x12 stainless steel screw *1
- E** M4x9 stainless steel screw *3

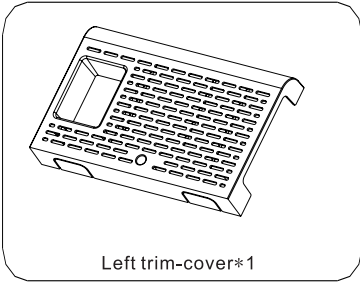

Left trim-cover*1

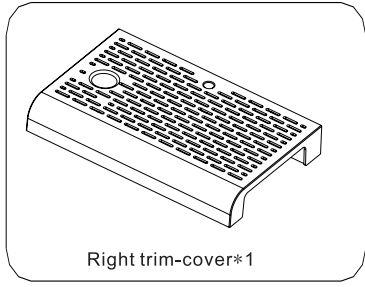

Right trim-cover*1

1-2 Checking the APX 5.0P-B1 packing list

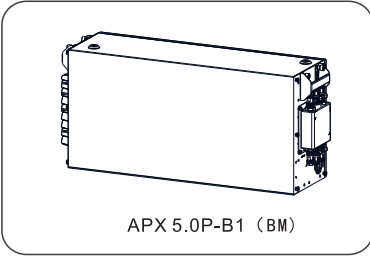

APX 5.0P-B1 (BM)

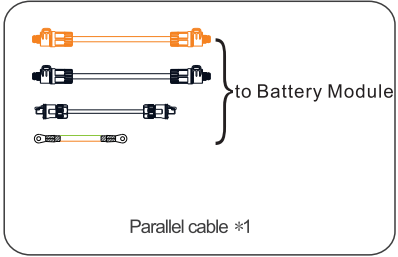

Parallel cable *1

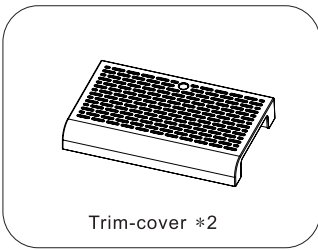

Trim-cover *2



Warranty card *1

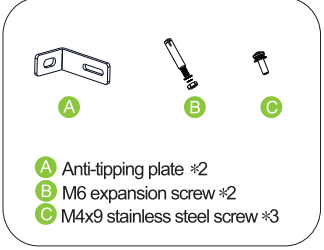

- A Anti-tipping plate *2
- B M6 expansion screw *2
- C M4x9 stainless steel screw *3

1-3 Check accessories

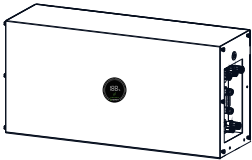

APX 98020-P1

A

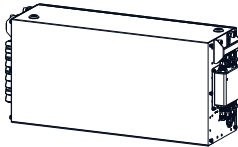

APX 5.0P-B1

B

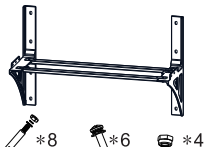

Wall bracket

C

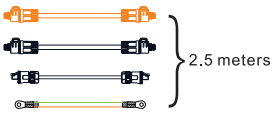

APX 5.0P-B1 Parallel extension cable

D



APX 5.0P-B1 Base

E



Cascading cable

F

Battery Capacity	Floor-mounted Installation Compound Mode	Wall-Mounted Installation Compound Mode
5kWh	A+B+E	A+B+C
10kWh	A+B*2+E	A+B*2+C
15kWh	A+B*3+E	A+B*3+C
20kWh	A+B*4+E	A+B*4+C
25kWh	A+B*5+E*2+D	A+B*5+C*2+D
30kWh	A+B*6+E*2+D	A+B*6+C*2+D

2. Installation Environment Requirement

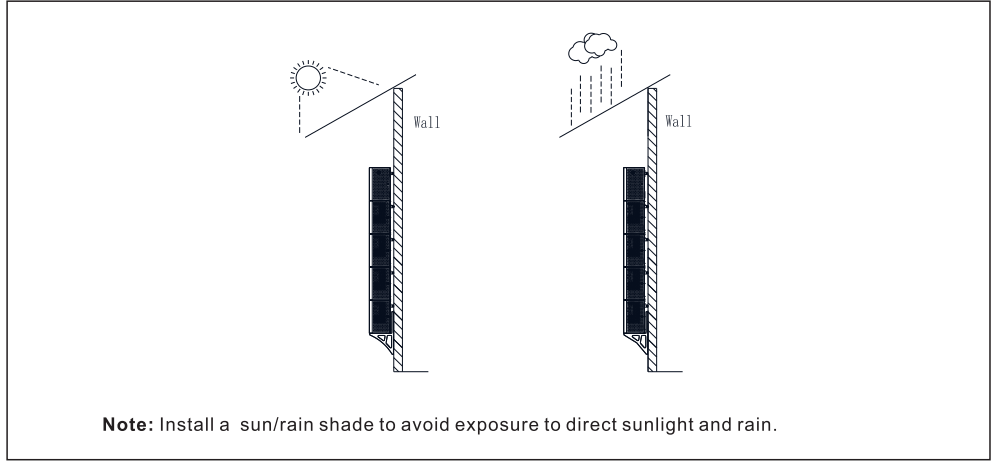

3. Floor-mounted installation

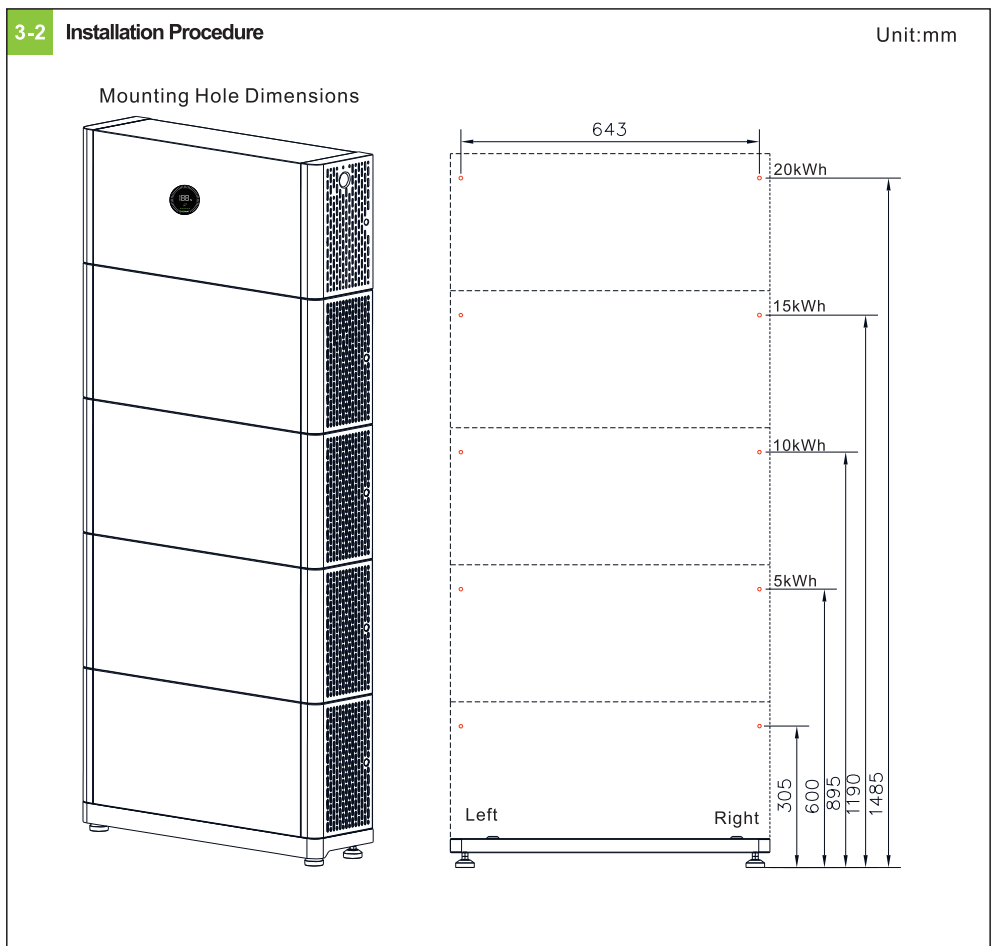
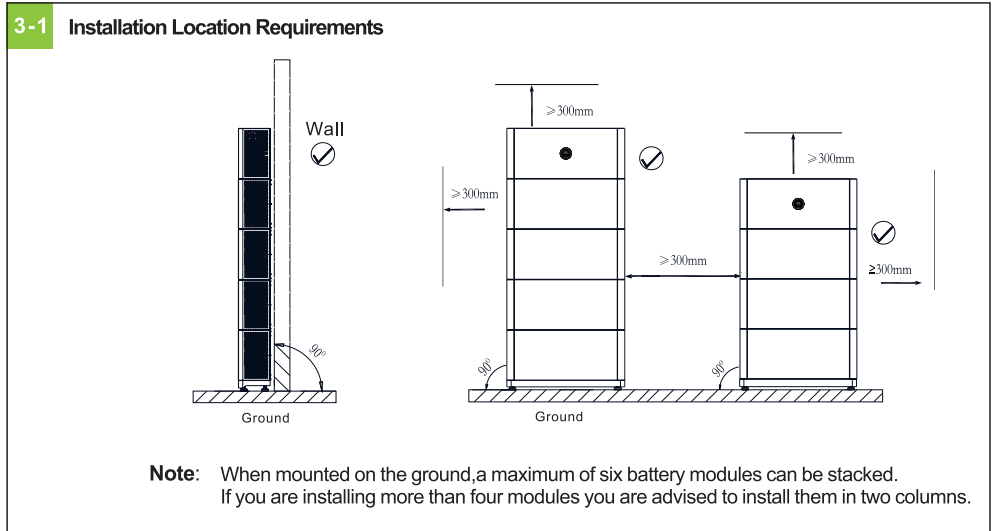

1

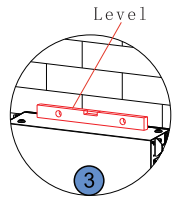
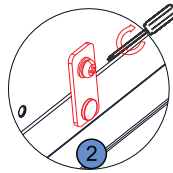
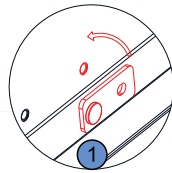
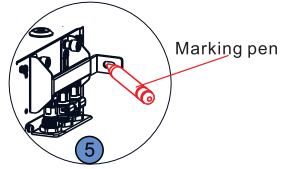
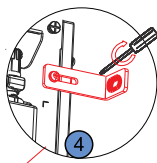
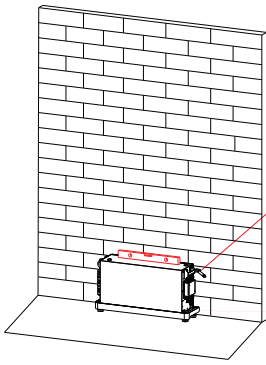

- ① ② Install the connecting pieces on both sides and tighten the two screws .
- ③ Level the battery module using a level.
- ④ Install the anti-tipping plates on both sides and tighten the two screws .
- ⑤ Mark the hole positions.

2

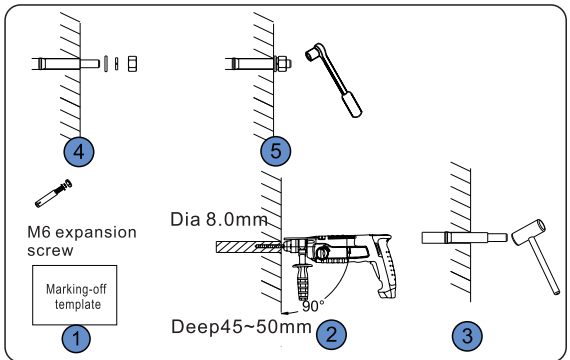
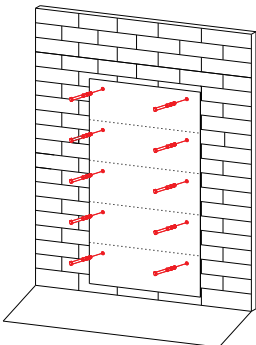

- ① The marking-off template ensures that the alignment marks are properly.
- ② ③ ④ ⑤ Fix the M6 expansion screw into the wall.

3

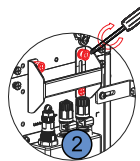
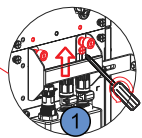
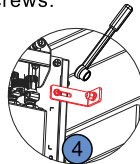
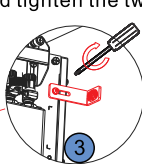
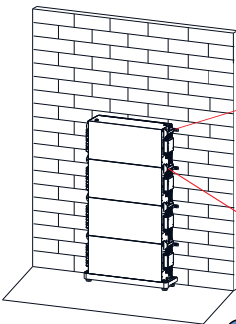

- ③ Install the connecting pieces on both sides and tighten the two screws.
- ④ Secure the module on both sides to the wall.
- ① Loosen two screw, move up the handle on both sides.
- ② Tighten the two screws, fix the two battery modules.

4

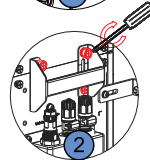
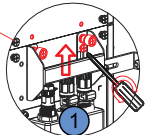
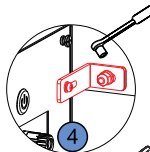
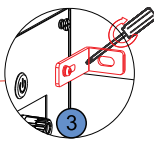
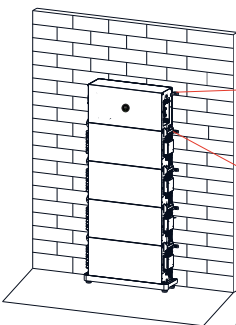

- ③ Install the connecting pieces on both sides and tighten the two screws.
- ④ Secure the module on both sides to the wall.
- ① Loosen two screw, move up the handle on both sides.
- ② Tighten the two screws, fix the battery and the power modules.

4. Wall-Mounted Installation

4-1 Installation Location Requirements

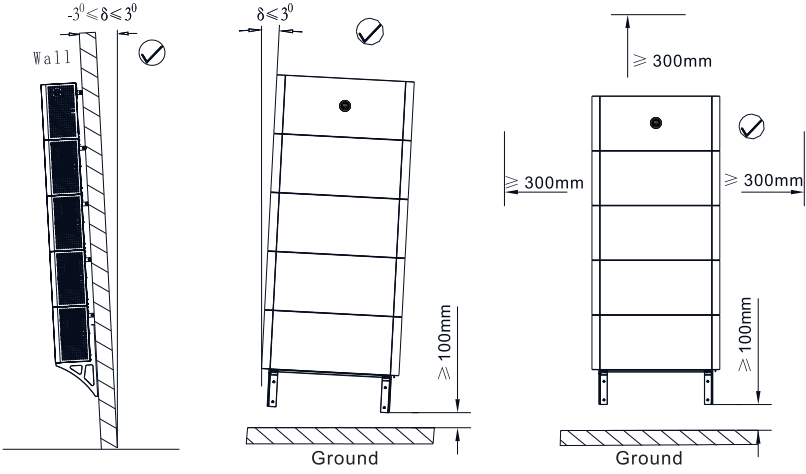

Note: When mounted on the wall, a maximum of five battery modules can be stacked. Please ensure that the load-bearing capacity of the wall exceeds 280 kg.

4-2 Installation Procedure

Unit:mm

Mounting Hole Dimensions

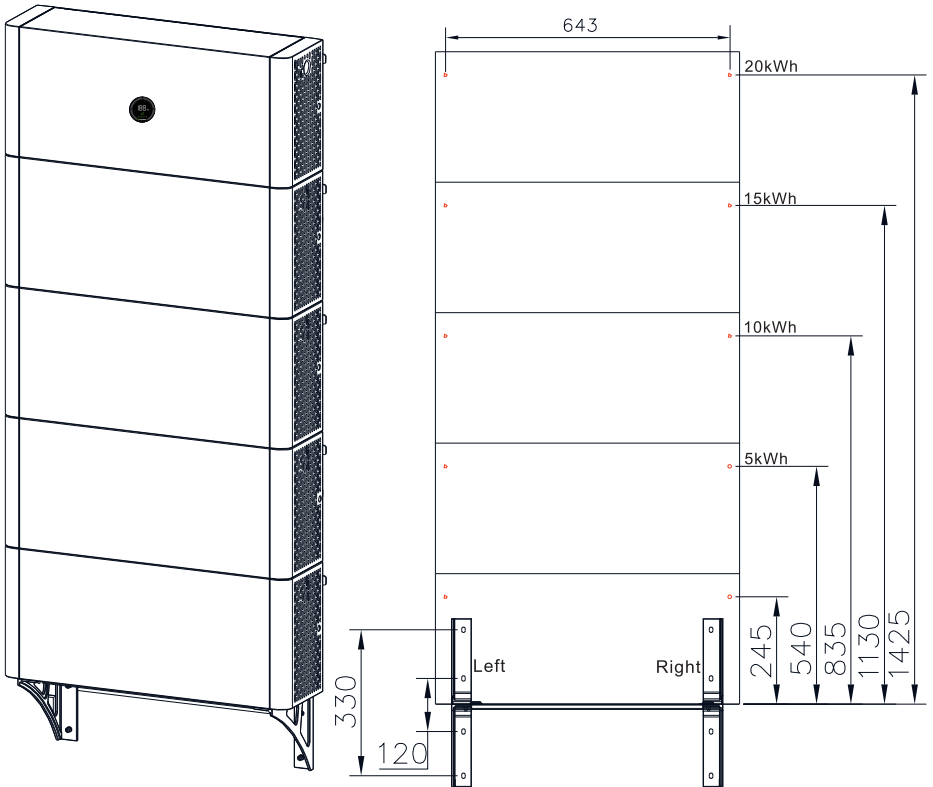

1

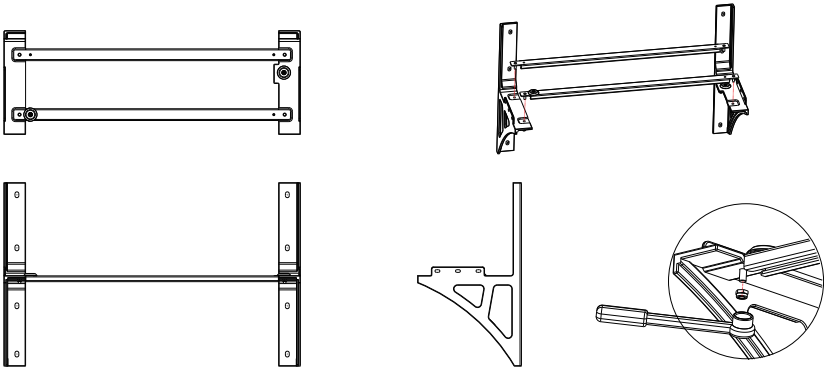

install the wall bracket

2

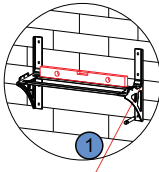
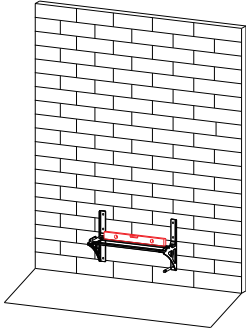

Level

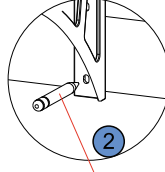

Marking pen

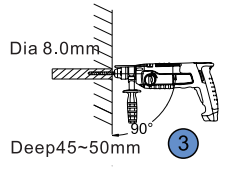

- 1 Level the battery Module using a level.
- 2 Mark the hole positions.
- 3 Drilling eight holes.

3

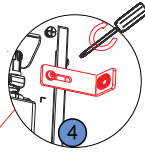
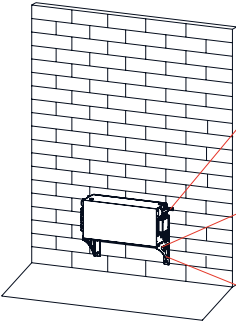

- 4 Install the anti-tipping plates on both sides and tighten the two screws.

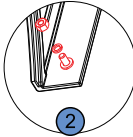
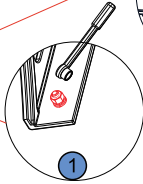
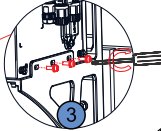

- 1 2 Fix the bracket on the wall.
- 3 Fix the battery module on the bracket.

4

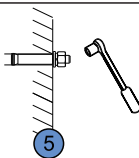
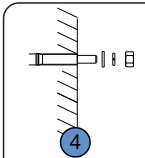
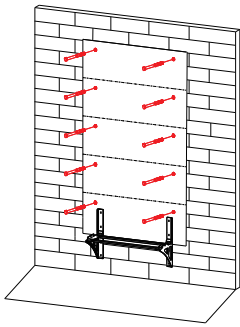

M6 expansion screw

Marking-off template

Dia 8.0mm
Deep 45-50mm

- 1 The marking-off template ensures that the alignment marks are properly placed on the wall.
- 2 3 4 5 Fix the M6 expansion screw into the wall.

5

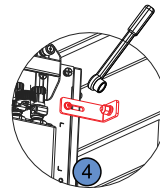
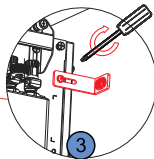
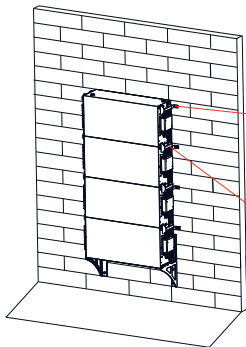

- 4 Secure the module on both sides to the wall.

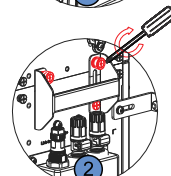
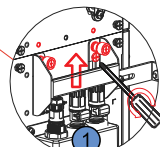

- 1 Loosen two screws, move up the handle on both sides.
- 2 Tighten the two screws, fix the two battery modules.

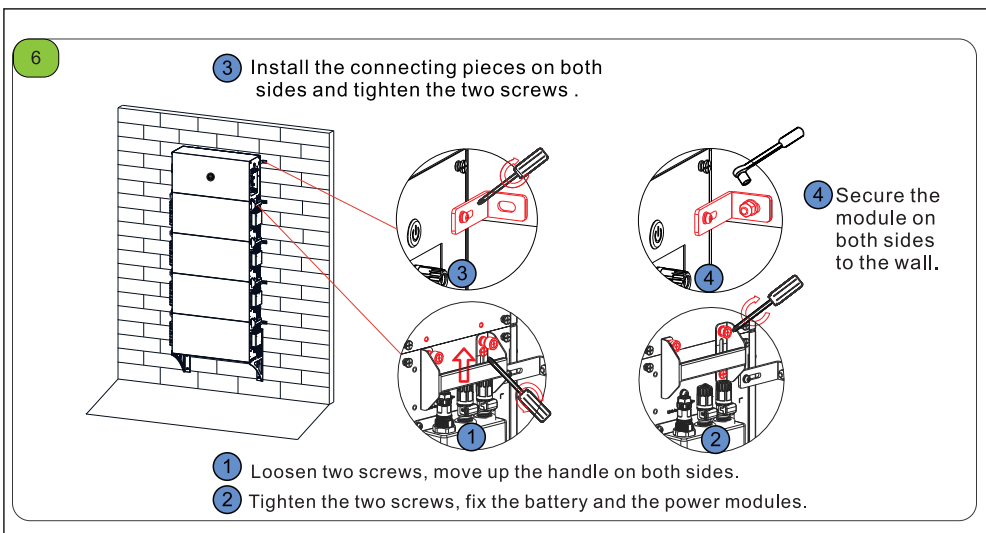

5.Wire Connection

5-1 APX 98020-P1 terminal & key description

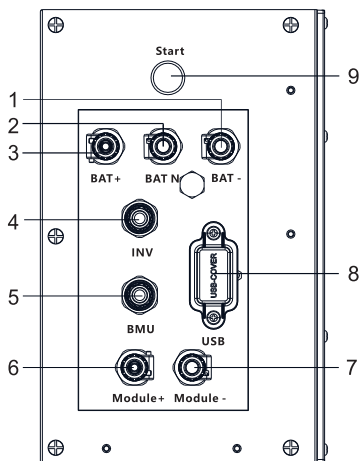

1	BAT-	Battery negative terminal to connected to the PCS
2	BAT N	Battery neutral terminal to connected to the PCS
3	BAT+	Battery positive terminal to connected to the PCS
4	INV	Communication terminal connect to the PCS
5	BMU	Communication terminal connect to the battery module (Link-in)
6	Module+	Connect to the positive battery terminal of the Battery Module (B+)
7	Module-	Connect to the positive battery terminal of the Battery Module (B-)
8	USB	USB terminal
9	Start	Start key

5-2 APX 5.0P-B1 Connection end face introduction

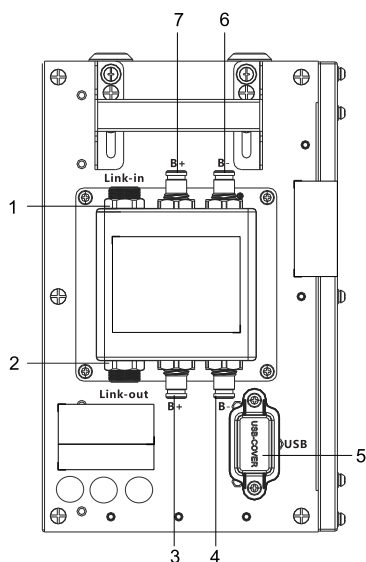

1	Link-in	Communication terminal Connect to another BM(Link-out) or the PM(BMU) Communication
2	Link-out	Communication terminal Connect to another BM(Link-in) or the PM(BMU)Communication
3	B+	Battery positive terminal Connect to another BM(B+)
4	B-	Battery negative terminal Connect to another BM (B-)
5	USB	USB terminal
6	B-	Battery negative terminal Connect to another BM(B-) or the PM (Module-)
7	B+	Battery positive terminal Connect to another BM(B-) or the PM (Module-)

5-3 Battery Capacity Description

The battery supports power and capacity expansion. A maximum of six battery modules can be connected to a single power module.

— DC input cable
— Signal cable

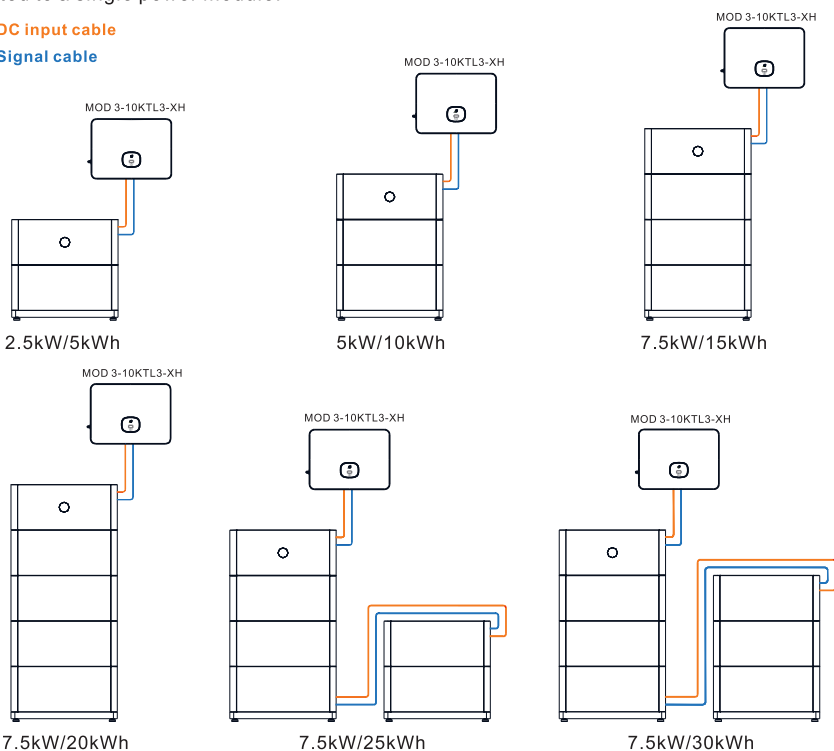

5-4 Wiring diagram

To PCS
BAT N
BAT+
BAT-
INV

NOTE: Battery modules MUST be paralleled with B+ to B+, B- to B-

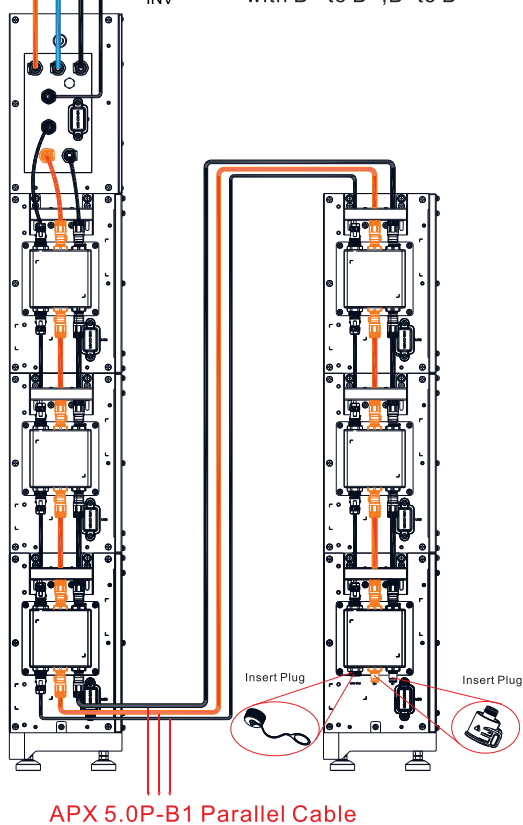

wire connection sequence:

ground cable \Rightarrow communication cable \Rightarrow power cable

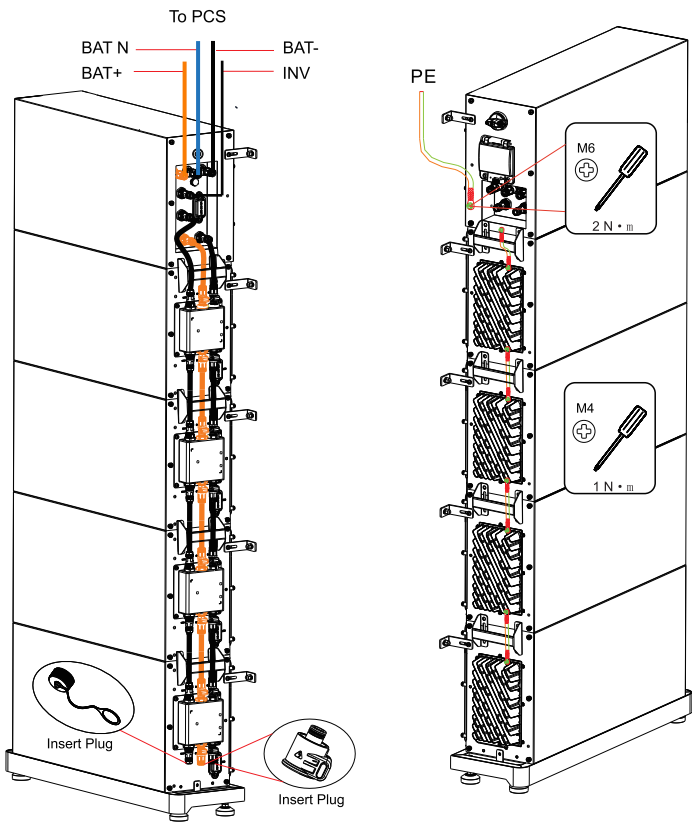

Note: It is not recommended to install a DC circuit breaker between the battery system and the PCS. If you want to install a DC circuit breaker with rated working voltage greater than 1000V and rated working current greater than 63A, do not operate the DC circuit breaker with power-on, otherwise the machine may be damaged.

5-5 Routing Cables Out of the Cable Hole

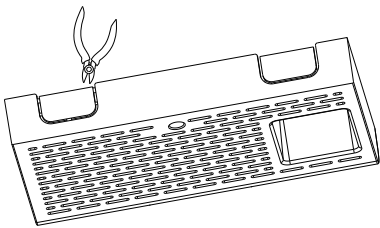

APX 98020-P1 Left trim-cover

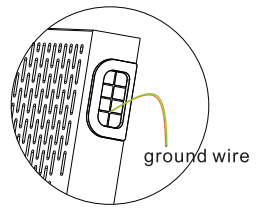
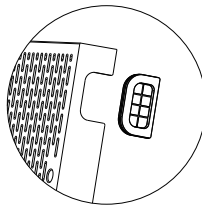

ground wire

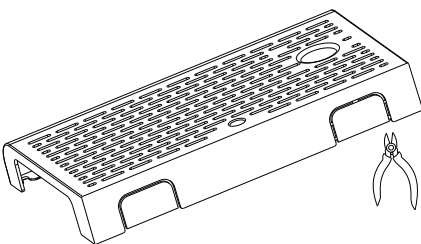

APX 98020-P1 Right trim-cover

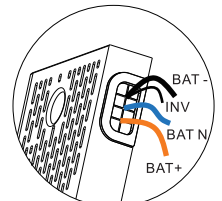
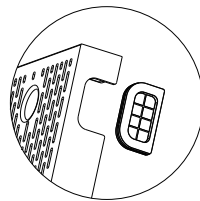

BAT -
INV
BAT N
BAT +

5-6 Communication port connection

APX 5. 0-30. 0P-S1			MOD 3-10KTL3-XH		
Silk screen	Terminal serial number	Definition	Silk screen	Terminal serial number	Definition
INV	1	WAKE- (W-)	COM	10	BAT.EN-
	2	WAKE+ (W+)		9	BAT.EN+
	7	RS485_B (B)		8	RS485B2
	8	RS485_A (A)		7	RS485A2

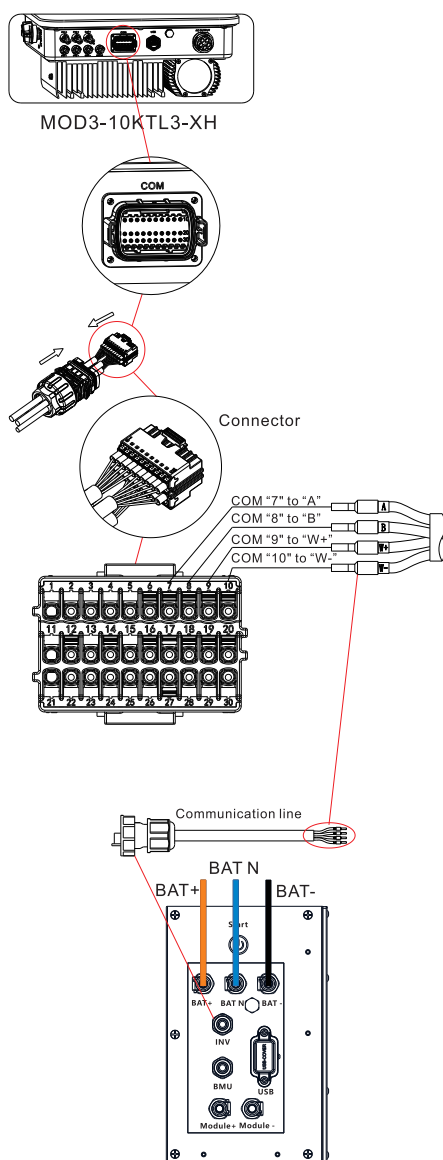

6. Terminal Connection

6-1 Power terminal

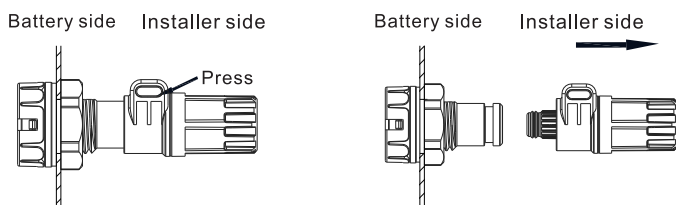

Note: Press the position indicated in the figure above before disconnecting the power terminal.

6-2 Installing the trim-cover

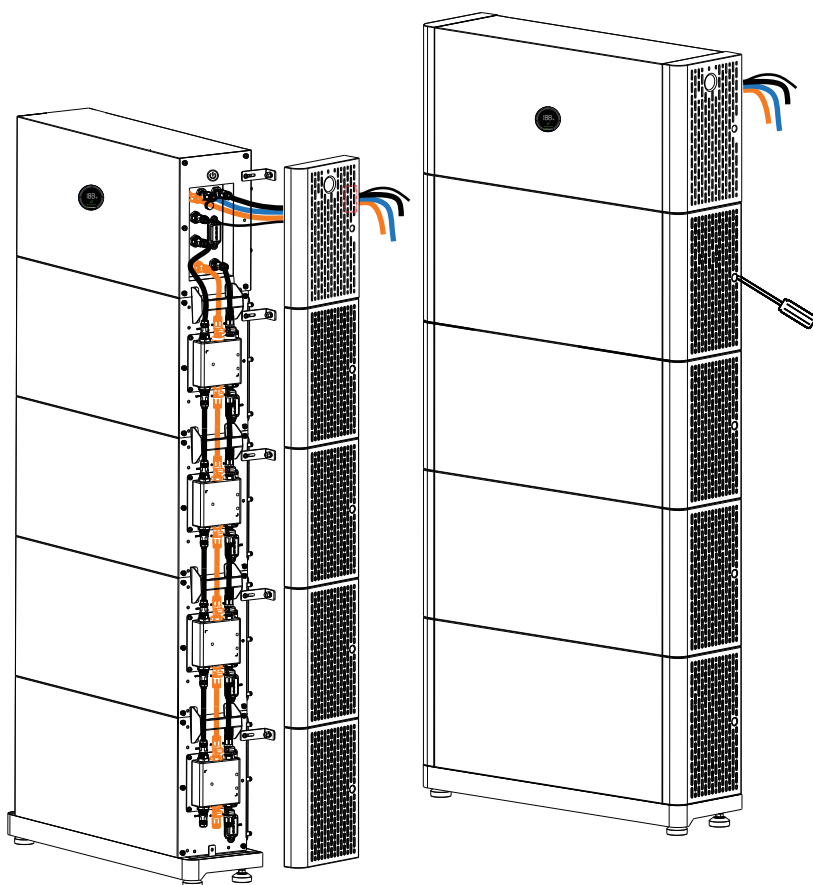

7. Key operation

Power on	<ol style="list-style-type: none"> 1. Turn on the DC Switch 2. Press the start key for more than 5S 	
Power off	Turn off the DC Switch (waiting for over 90S)	

- Note:** 1. Before performing maintenance and repair work, ensure that the AC circuit breaker and the PV switch of the PCS, as well as the switch of the APX are disconnected. **Wait for 15 minutes after the system is powered off and make sure that the LOGO (GROWATT) indicator on the APX is off.** Do not perform any operations until the system is completely shut down.
2. When multiple battery systems are used in parallel connection, you only need to press the start key of one module to start the system.

8. Service and contact

Shenzhen Growatt New Energy Co., Ltd

4-13/F, Building A, Sino-German (Europe) Industrial Park, Hangcheng Ave, Bao'an District, Shenzhen, China

+86 755 2747 1942 service@ginverter.com

W:www.ginverter.com



Download Manual



Search Growatt New Energy

GR-UM-339-A-00