



Single-phase Hybrid Inverter

USER MANUAL

HYS-8.0LV-EUG2
HYS-10.0LV-EUG2
HYS-12.0LV-EUG2

CONTENTS











1. Safety Introduction	03
1.1 Explanation of Symbols	03
1.2 Safety Information	04
2. Product Introduction	06
2.1 Product Overview	06
2.2 Product Dimensions	07
2.3 LED Indicators	08
2.4 Operating Modes	10
2.5 System Diagram	12
2.5.1 Basic Diagram	13
2.5.2 Unacceptable Diagram	15
3. Installation Instruction	16
3.1 Packing List	16
3.2 Installation Tools	16
3.3 Mounting	17
3.3.1 Selecting the Mounting Location	17
3.3.2 Mounting Inverter	18
3.4 Electrical Connection	19
3.4.1 Recommended Cable List	19
3.4.2 Opening the Wiring Box Cover	19
3.4.3 Ground Cable Connection	20
3.4.4 PV Cable Connection	20
3.4.5 Battery Cable Connection	21
3.4.6 AC Cable Connection	22
3.4.7 Communication Cable Connection	23
3.4.7.1 Smart Meter and CT Connection	24
3.4.7.2 DI Connection	25
3.4.7.3 DO Connection	25
3.4.7.4 External Emergency Power Off Switch Connection (Optional)	26
3.4.7.5 BMS Connection	26
3.4.7.6 DTS Connection	27
3.4.8 Installing the Wiring Box Cover	28
3.5 Operation	29
3.5.1 Commissioning	29
3.5.2 Decommissioning	29
3.5.3 S-Miles Cloud App	30
3.5.3.1 DTS Online Setting	30
3.5.3.2 System Commissioning of Wireless Access Point (AP) Connection	32





4. Troubleshooting	34
5. Technical Datasheet	37

1. Safety Introduction

1.1 Explanation of Symbols

The following types of safety precautions and general information symbols used in this manual must be followed during the installation, operation, and maintenance of the inverter.

Symbol	Usage
	Indicates a hazard with a high level of risk that, if not avoided, will result in death or serious injury.
	Indicates a hazard with a medium level of risk that, if not avoided, can result in death or serious injury.
	Indicates a hazard with a low level of risk that, if not avoided, can result in minor or moderate injury.
	Indicates a situation that, if not avoided, can result in property damage. NOTICE is used to address practices not related to personal injury.
	Caution! Failure to observe any warnings contained in this manual may result in injury.
	Danger to life due to high voltages! Only qualified personnel can open and maintain the inverter.
	Burn danger due to hot surface that may exceed 60°C.
	Refer to the operating instructions.
	After the inverter is turned off, wait for at least 5 minutes before opening the inverter or touching live parts.
	Products shall not be disposed as household waste.
	CE mark.



	<p>This side up! This package must always be transported, handled, and stored in such a way that the arrows always point upwards.</p>
	<p>Fragile - The package/product should be handled carefully and should never be tipped over or slung.</p>
	<p>Keep dry! The package/product must be protected from excessive humidity and must be stored under cover.</p>
	<p>A maximum of six (6) identical packages can be stacked.</p>



1.2 Safety Information

This chapter contains important safety and operating instructions. For future reference, please read and keep this manual.

For the purpose of preventing personal injury and property damage, as well as ensuring the long-term operation of the product, please read and follow all the instructions and cautions on the inverter and in this user manual during installation, operation, and maintenance.

Safety instructions in this manual cannot cover all precautions that should be taken. Please consider the actual conditions when performing operations. Any damage caused by a violation of the safety instructions in this manual shall not be the responsibility of Hoymiles.

Symbol	Usage
 <p>DANGER</p>	<p>Danger to life from electric shock</p> <ul style="list-style-type: none"> • Before performing any work on the inverter, disconnect all DC and AC power from inverter and wait for at least 5 minutes. The hazardous voltage will exist for up to 5 minutes after disconnection from power supply. • Never insert or remove the AC or DC connections when the inverter is running. • Any live parts connected to battery ports cannot be touched before removing all the power from the inverter for 5 minutes because there is still danger to life even battery voltage is lower than 60 V. • Do not touch DC conductors or any non-isolated cable ends. • The mounting location must be inaccessible to children. • Never touch either the positive or negative pole of PV connecting device. Strictly prohibit touching both at the same time.
 <p>WARNING</p>	<p>Risk of burns from hot surfaces</p> <ul style="list-style-type: none"> • The surface of the inverter might exceed 60°C, and touching the surface may result in burns. • Do not touch hot surfaces before it cools down.

	<ul style="list-style-type: none"> • Only authorized service personnel are allowed to install the inverter or perform servicing and maintenance. • All powers, both AC and DC, should be disconnected from the inverter before attempting any maintenance, cleaning, or working on any circuits connected to the inverter. • Attempting to service the inverter yourself may result in a risk of electric shock or fire and will void your warranty. • Keep away from flammable and explosive materials to avoid fire disasters. • The installation place should be away from humid or corrosive substances. • The unit contains capacitors that remain charged to a potentially lethal voltage after the mains, battery, and PV supply have been disconnected. • When accessing the internal circuit of the inverter, wait for at least 5 minutes after disconnecting the power.
	<ul style="list-style-type: none"> • The inverter has a transformerless design on the PV side. Neither positive nor negative terminals of PV panels should be grounded. • The frames of PV panels should be grounded for safety reasons. • Ensure that existing wiring is in good condition and no wire is undersized. • Do not disassemble any parts of the inverter which are not mentioned in the installation. • Authorized service personnel must use insulated tools when installing or working with this equipment. • PV modules shall have an IEC 61730 class A rating.
	<ul style="list-style-type: none"> • The minimum rated temperature of the wire used is 90°C. • All electrical connections must be in accordance with local and national standards. • Only with permission of the local utility grid company, the inverter can be connected to the utility grid. • Do not open the inverter cover or change any components without authorization, otherwise the warranty commitment for the inverter will be invalid. • Appropriate methods must be adopted to protect the inverter from electrostatic discharge; any damage caused by ESD is not warranted by the manufacturer. • Prior to the application, please read this section carefully to ensure correct and safe application. Please keep the user manual properly. • The manual contains no instructions for user-serviceable parts. See Warranty for instructions on obtaining service. • If an error occurs, contact your local distributor or qualified electricians.

2. Product Introduction

2.1 Product Overview

The HYS-LV series is a high-performance single-phase hybrid inverter with excellent reliability. The intelligent EMS function supports self-consumption, economic, and backup modes for multi-scenario applications. Monitoring management through S-Miles Cloud allows users to remotely diagnose and track the system performance over time, offering superior energy production.

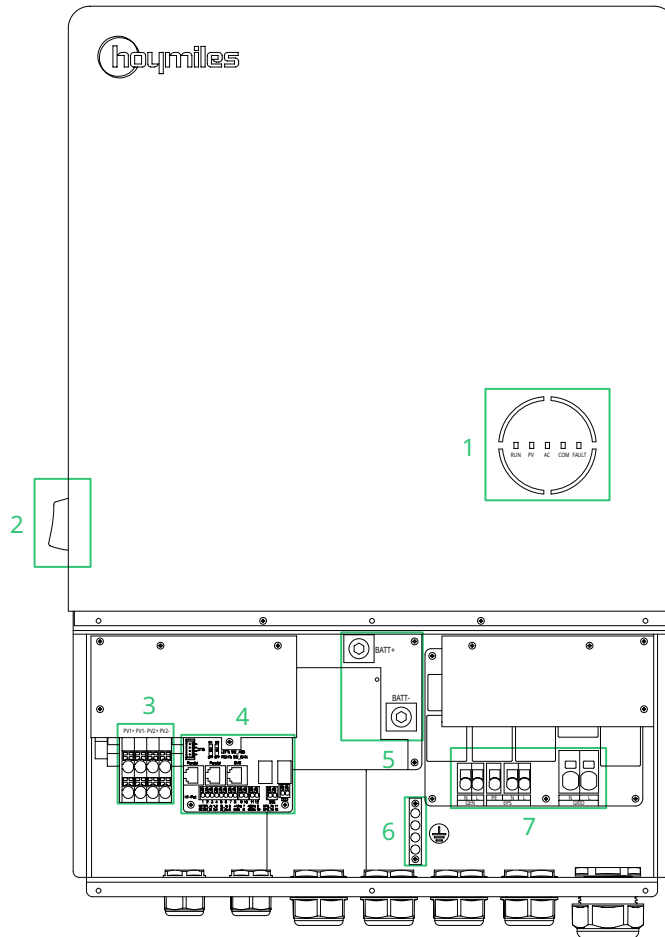

* The image shown here is for reference only. The actual product received may differ.

Object	Description
1	LED Indicators
2	DC Switch
3	PV Terminals
4	Communication Port
5	Battery Terminals
6	Grounding Bar
7	AC Terminals

2.2 Product Dimensions

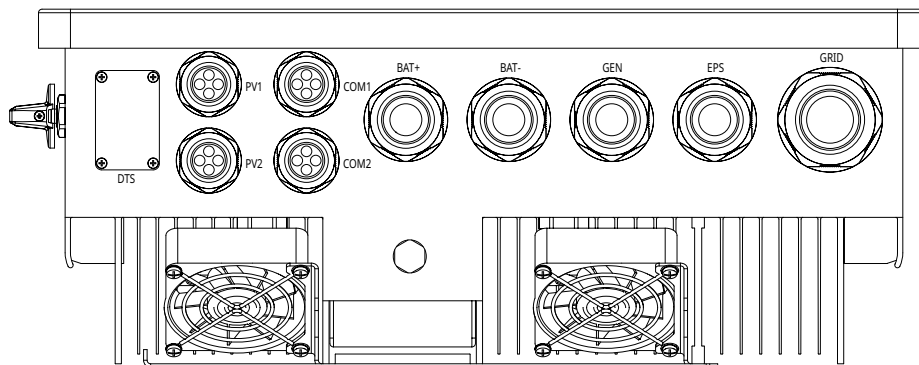
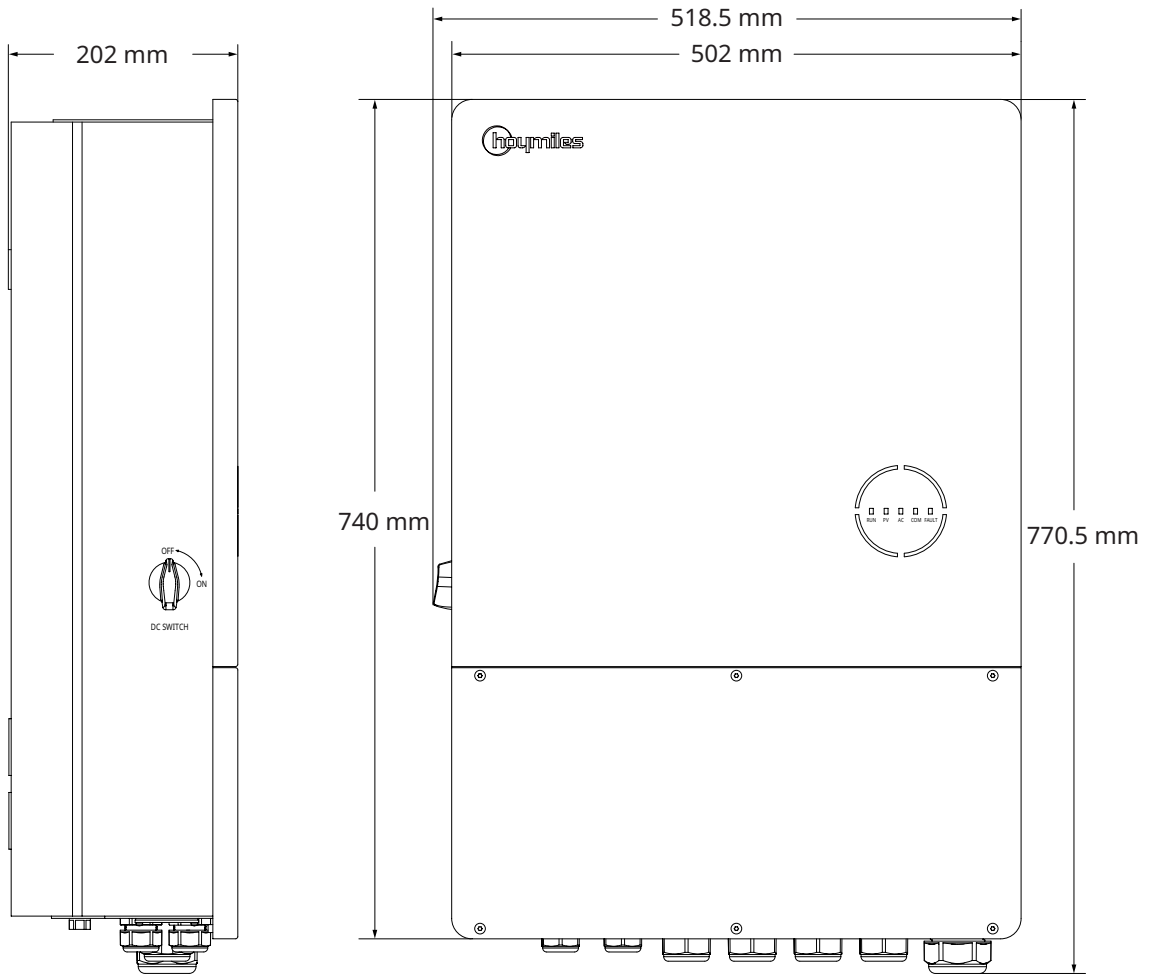

2.3 LED Indicators

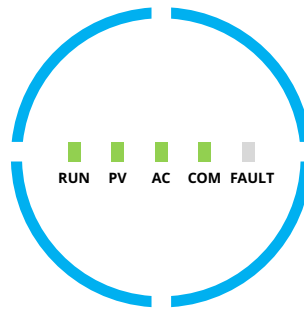

Indicator	Status	Explanation
SOC	<p>Full circle LEDs on – SOC is 75-100%; battery is discharging or in standby Full circle LEDs blink – SOC is 75-100%; battery is charging</p>	<p>Full circle LEDs on – SOC is 75-100%; battery is discharging or in standby Full circle LEDs blink – SOC is 75-100%; battery is charging</p>
	<p>3/4 circle LEDs on – SOC is 50-75%; battery is discharging or in standby 3/4 circle LEDs blink – SOC is 50-75%; battery is charging</p>	<p>3/4 circle LEDs on – SOC is 50-75%; battery is discharging or in standby 3/4 circle LEDs blink – SOC is 50-75%; battery is charging</p>
	<p>2/4 circle LEDs on – SOC is 25-50%; battery is discharging or in standby 2/4 circle LEDs blink – SOC is 25-50%; battery is charging</p>	<p>2/4 circle LEDs on – SOC is 25-50%; battery is discharging or in standby 2/4 circle LEDs blink – SOC is 25-50%; battery is charging</p>
	<p>1/4 circle LED on – SOC is 0-25%; battery is discharging or in standby 1/4 circle LED blinks – SOC is 0-25%; battery is charging</p>	<p>1/4 circle LED on – SOC is 0-25%; battery is discharging or in standby 1/4 circle LED blinks – SOC is 0-25%; battery is charging</p>
	<p>Full circle LEDs off – No BMS communication</p>	<p>Full circle LEDs off – No BMS communication</p>

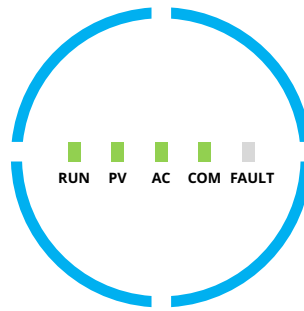

Indicator	Status	Explanation
RUN		Off - Inverter is shut down Blink 1 - Inverter is booting Blink 2 - Inverter is in bypass mode On - Inverter is turned on
PV		Off - PV voltage is low Blink 1 - PV power is low On - PV is generating power
AC		Off - Grid is disconnected and EPS is off Blink 1 - Grid is disconnected but EPS is on On - Grid is connected
COM		Off - Communication error of both meter and BMS Blink 1 - Communication failed to meter Blink 2 - Communication failed to BMS On - Both meter and BMS communications are normal
FAULT		Off - No fault On - A fault occurs Blink 1 - EPS port overload Blink 2 - ISO/RCD fault Blink 3 - Arc fault

2.4 Operating Modes

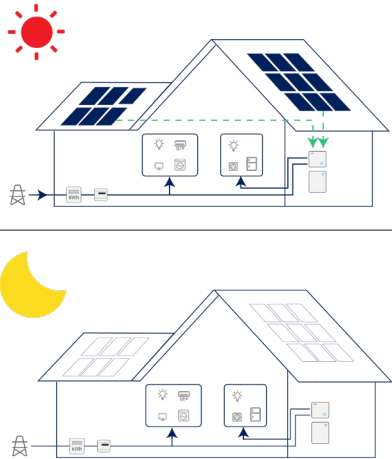
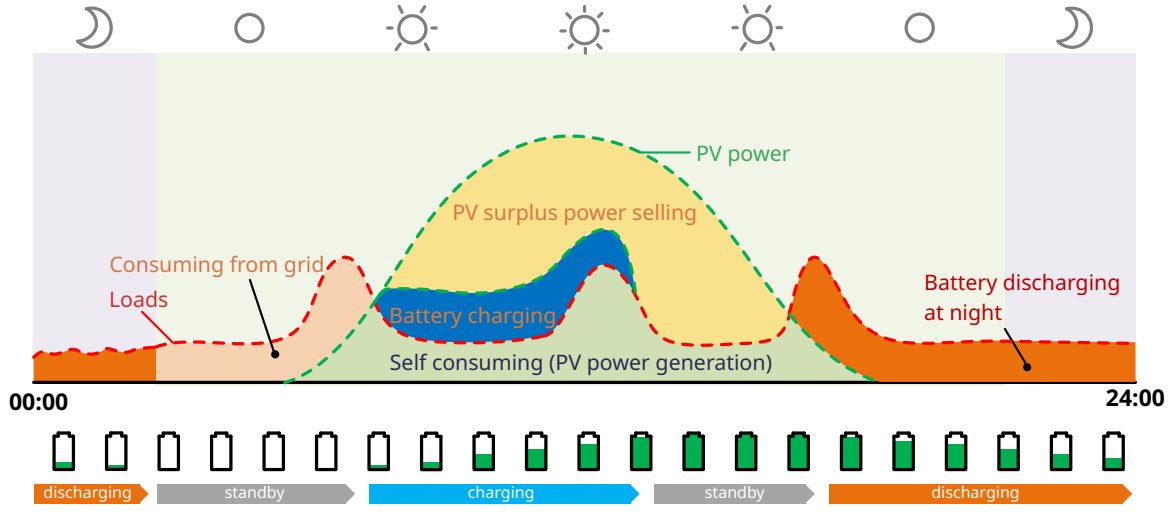
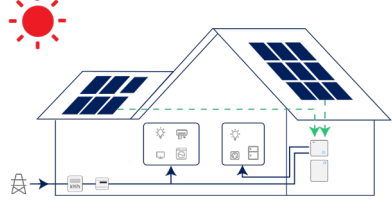
Main Operation Modes		
<p>Self-consumption Mode</p>	<p>In the daytime, solar energy supports the loads first and surplus energy is stored in the battery. When the battery is fully charged or reaches the maximum charge power, the rest energy is fed into the grid (or limited if required).</p> <p>At night, the battery discharges for the loads first and the grid will supply the loads once the battery power is not enough. In this mode, the battery cannot be charged from the grid at night.</p>	
		
Power flow of self-consumption mode		
<p>Economic Mode</p>	<p>In this mode, the time of battery charge and discharge needs to be set. The battery can be forced to charge from the grid during the preset charge time. For instance, the battery could be charged or discharged according to valley or peak electricity price.</p>	

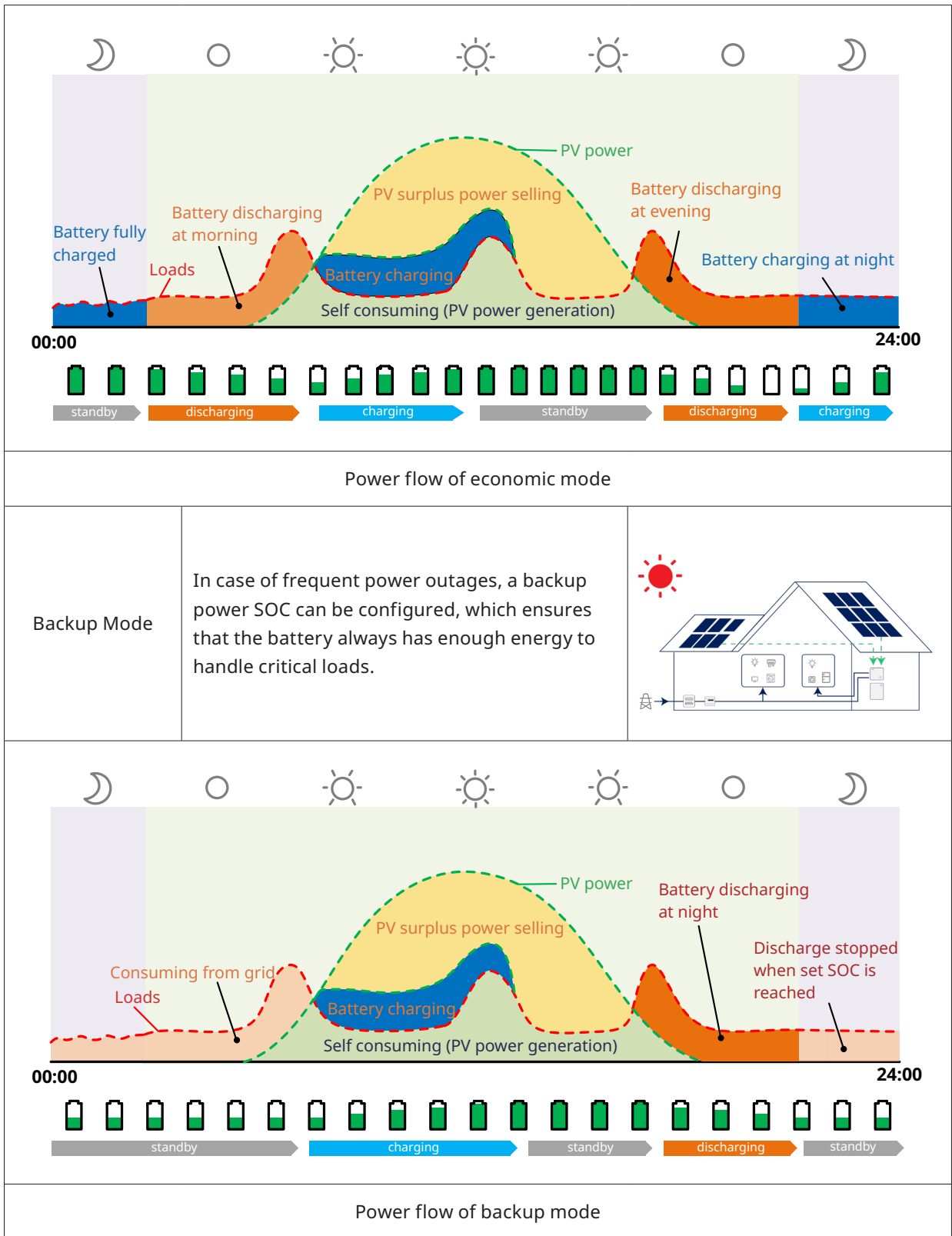

2.5 System Diagram

The HYS-LV series inverter can be connected to a battery and PV panels to form a PV Energy Storage System (ESS). In the event of a grid outage, it can be used as an emergency power supply (EPS) through the self-consumption of solar energy. It can form a DC-coupled system for a new installation or an AC-coupled system to retrofit existing installations.

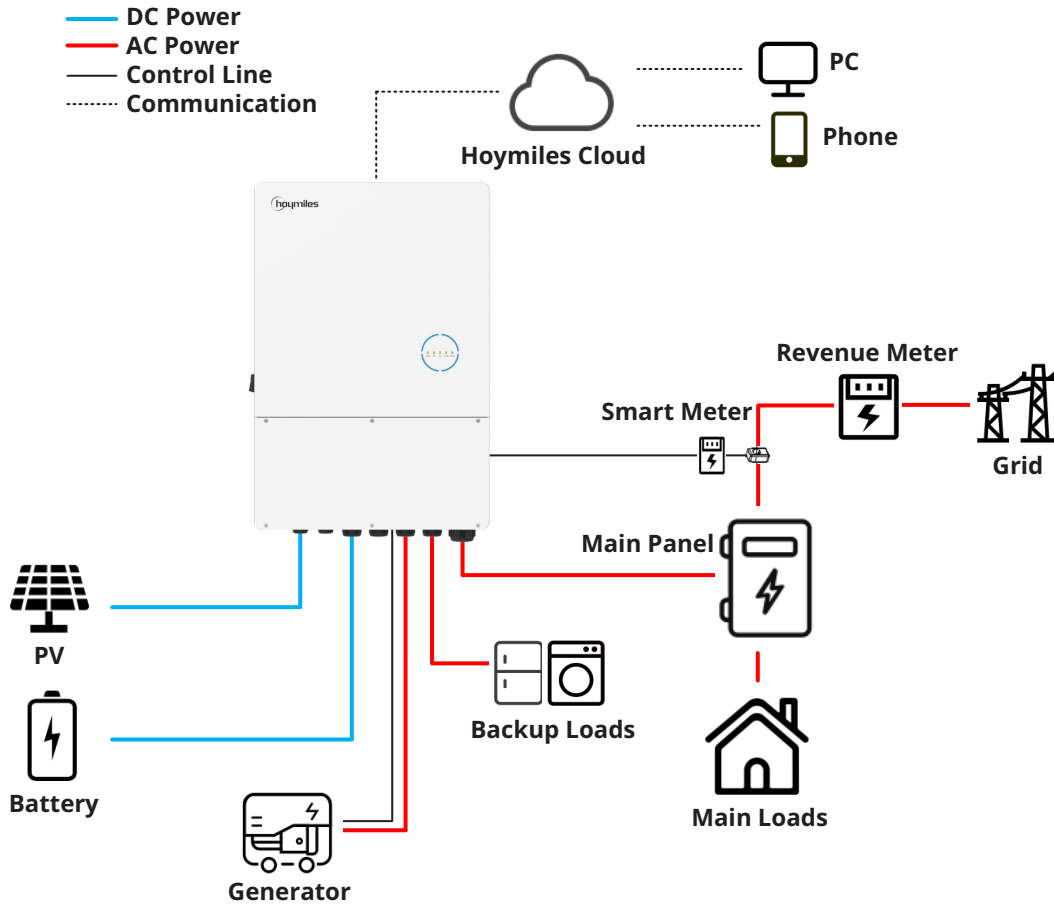

 <p>NOTICE</p>	<ul style="list-style-type: none"> • This diagram is a simplified system sketch that is only intended to explain system architecture. • Please refer to https://www.hoymiles.com for the compatible battery list, and the user should first contact Hoymiles for technical consultation and obtain official confirmation before installing any battery not included in the official published list. • Lead-acid battery is not recommended for general customers as it requires experienced installers and technicians who can fully understand the battery parameters and configure the settings and installations correctly. Please contact Hoymiles for technical support on lead-acid battery installation.
--	---

2.5.1 Basic Diagram

A. Diagram for Australia, New Zealand, South Africa, etc.

 <p>NOTICE</p>	<ul style="list-style-type: none"> This diagram is an example of application in which the neutral connects with PE in the distribution box. For countries such as Australia, New Zealand, South Africa, etc., please follow local wiring regulations!
--	---

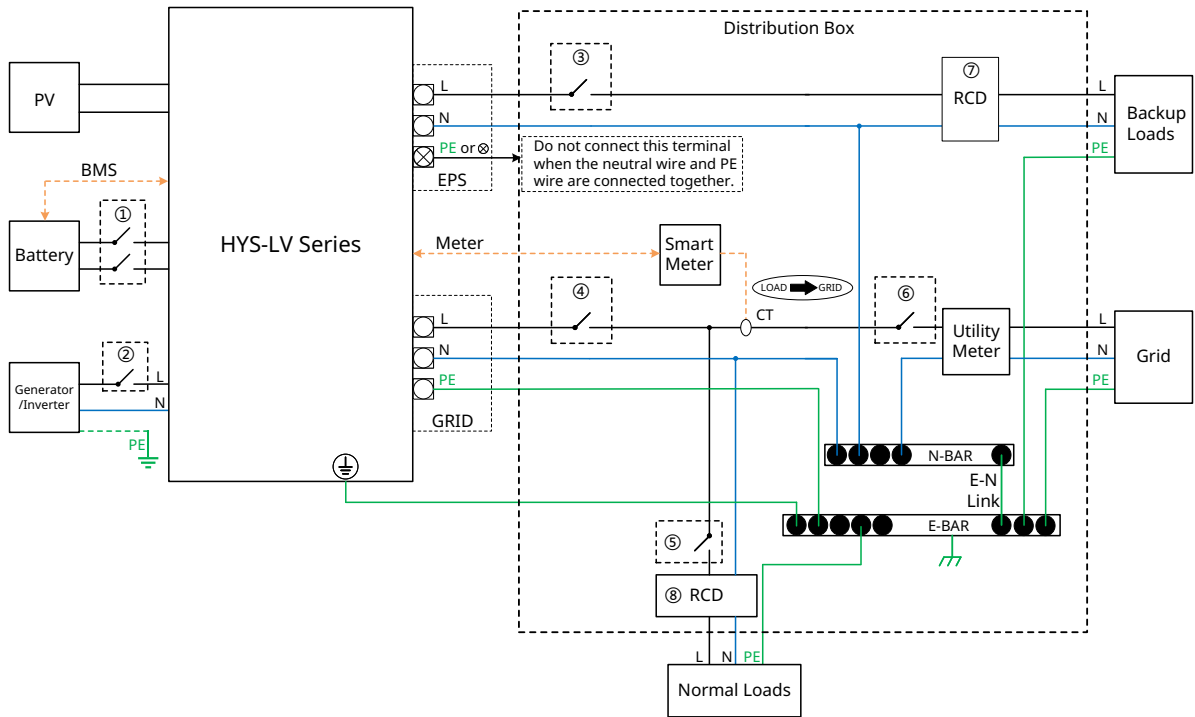

Model	①	②	③	④	⑤	⑥	⑦⑧
HYS-8.0LV-EUG2	200 A/60 V DC Fuse	50 A/230 V AC Breaker	50 A/230 V AC Breaker	125 A/230 V AC Breaker			
HYS-10.0LV-EUG2	250 A/60 V DC Fuse	63 A/230 V AC Breaker	63 A/230 V AC Breaker	125 A/230 V AC Breaker	Depends on Loads	Main Breaker	30 mA RCD
HYS-12.0LV-EUG2	300 A/60 V DC Fuse	80 A/230 V AC Breaker	80 A/230 V AC Breaker	125 A/230 V AC Breaker			

Note:

- If the battery integrates a readily accessible internal DC breaker or fuse, no additional ① DC breaker or fuse is required.
- If the generator has integrated a readily accessible internal AC breaker, then no additional ② AC breaker is required.
- ⑦⑧ 30 mA RCD is recommended but not mandatory; please comply with local regulations.

B. Diagram for Other Countries



NOTICE

- This diagram is an example of application in which the neutral is separated from the PE in the distribution box.
- For countries such as China, Germany, Italy, etc., please follow local wiring regulations!
- The backup PE line and earthing bar must be grounded properly and effectively. Otherwise, the backup function may be abnormal when the grid fails.

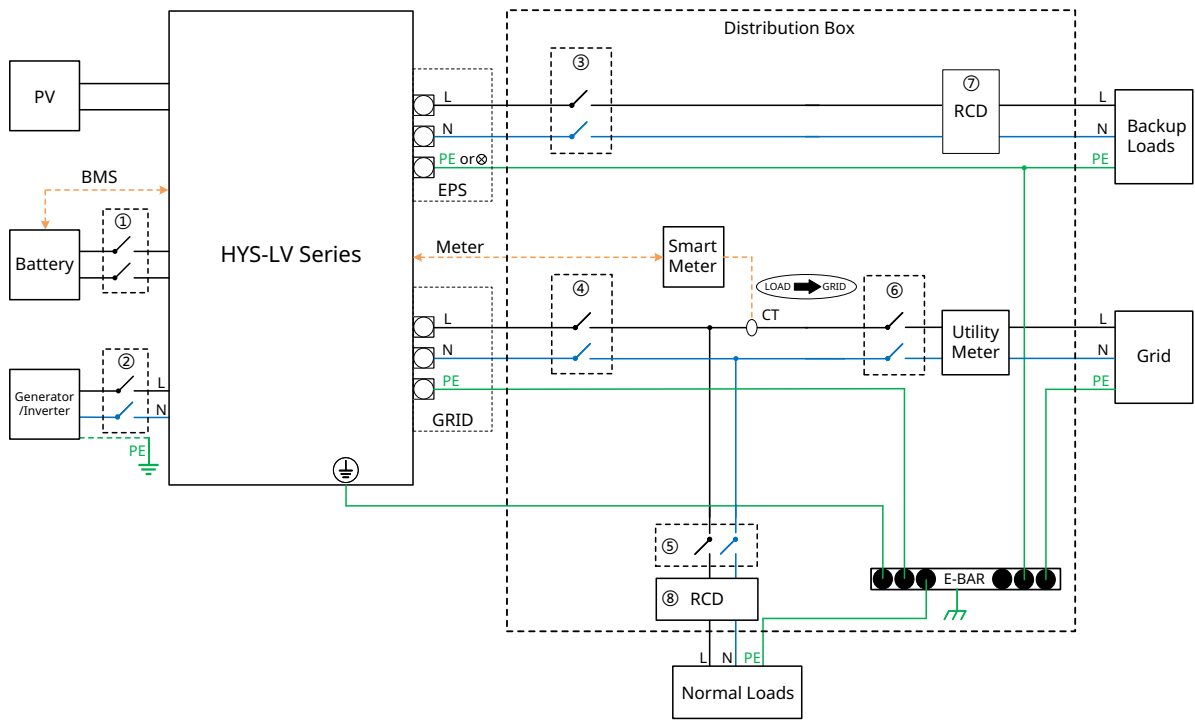

Model	①	②	③	④	⑤	⑥	⑦⑧
HYS-8.0LV-EUG2	200 A/60 V DC Fuse	50 A/230 V AC Breaker	50 A/230 V AC Breaker	125 A/230 V AC Breaker			
HYS-10.0LV-EUG2	250 A/60 V DC Fuse	63 A/230 V AC Breaker	63 A/230 V AC Breaker	125 A/230 V AC Breaker	Depends on Loads	Main Breaker	30 mA RCD
HYS-12.0LV-EUG2	300 A/60 V DC Fuse	80 A/230 V AC Breaker	80 A/230 V AC Breaker	125 A/230 V AC Breaker			

Note:

- If the battery integrates a readily accessible internal DC breaker or fuse, no additional ① DC breaker or fuse is required.
- If the generator has integrated a readily accessible internal AC breaker, then no additional ② AC breaker is required.
- ⑦⑧ 30 mA RCD is recommended but not mandatory; please comply with local regulations.

2.5.2 Unacceptable Diagram

Avoid the following installation types to prevent damage to the system or the inverter.

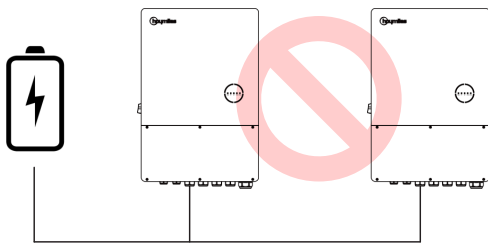

One battery cannot be connected to multiple inverters.

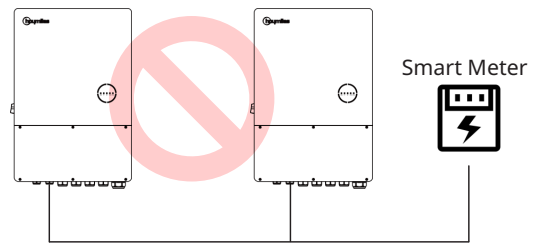

One meter cannot be connected to multiple inverters and different CTs cannot be connected to the same line cable.

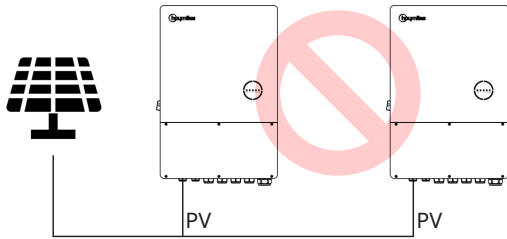

Single PV cannot be connected to multiple inverters.

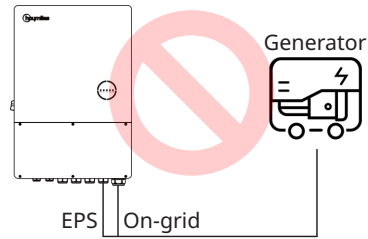

Neither EPS or on-grid port can be connected to generator directly.

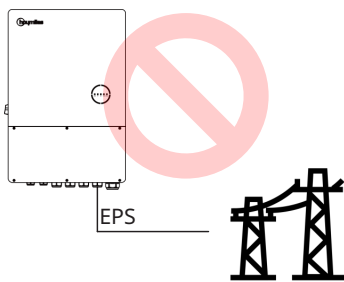

EPS port cannot be connected to grid directly.

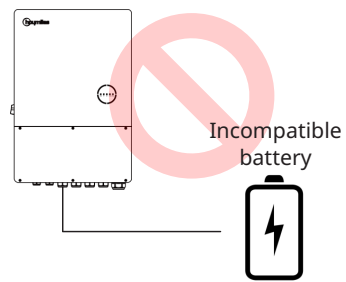

Incompatible battery cannot be connected to battery port.

3. Installation Instruction

3.1 Packing List

Please ensure that none of the components listed below are missing or damaged upon receipt of the hybrid inverter.

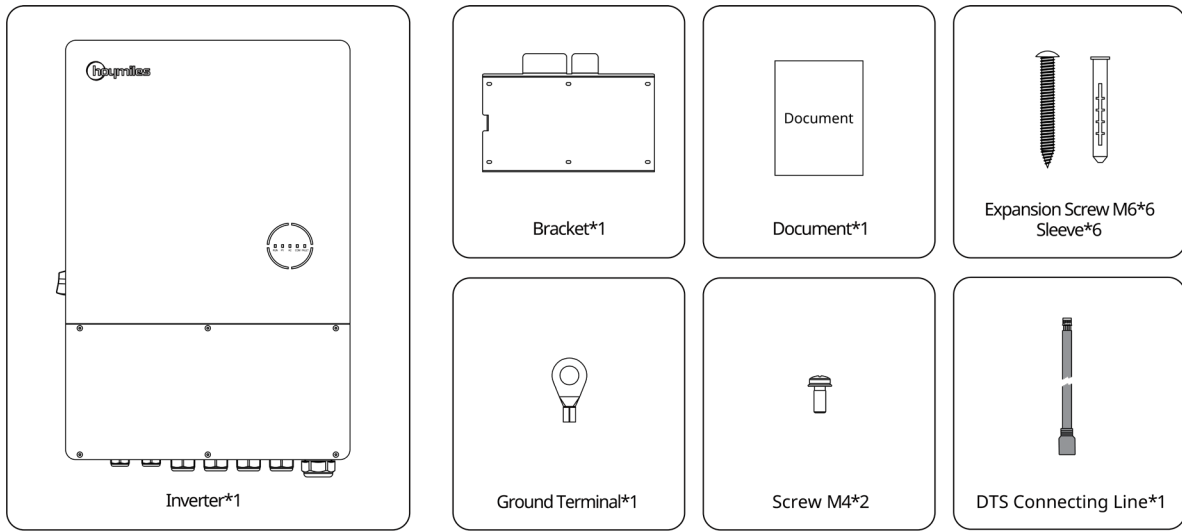

Accessories Packing List

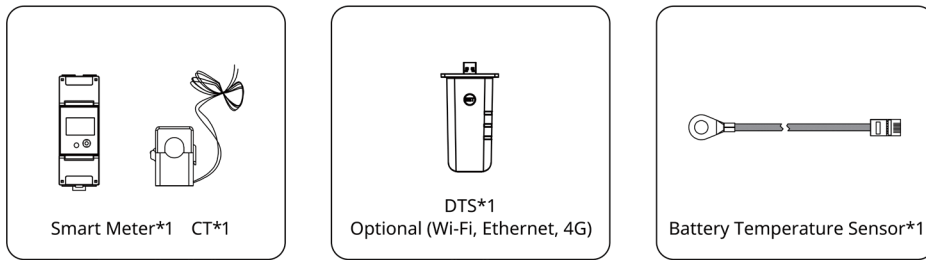

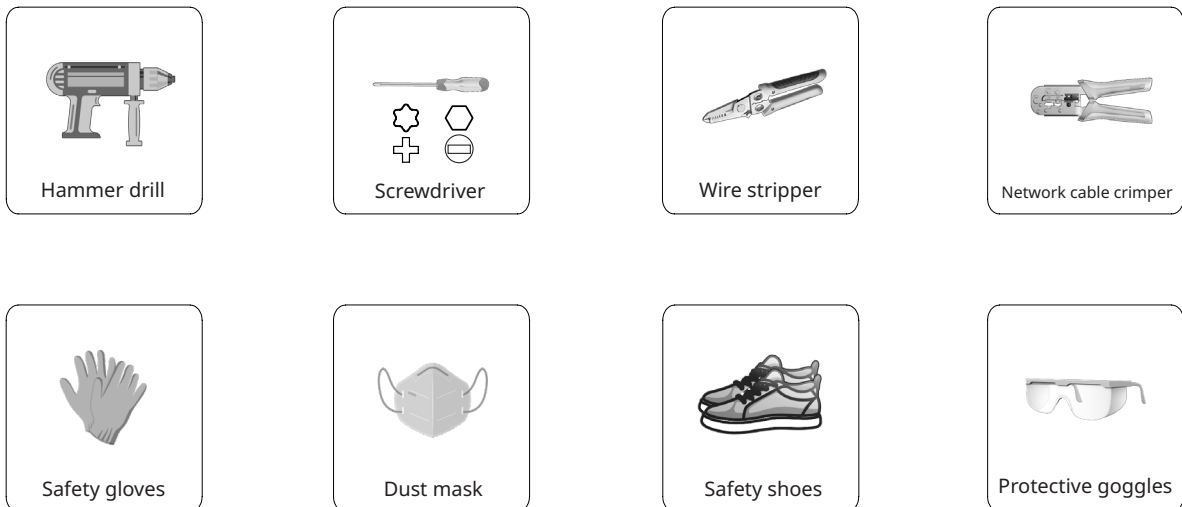

3.2 Installation Tools

The following tools are recommended in the installation process, and other auxiliary tools can also be used on site if necessary.



3.3 Mounting

3.3.1 Selecting the Mounting Location

 <p>WARNING</p>	<ul style="list-style-type: none"> • Make sure there is no electrical connection before installation. • In order to avoid electric shock or other injuries, make sure that holes are not drilled over any electrical parts or plumbing installations.
 <p>NOTICE</p>	<ul style="list-style-type: none"> • Make sure the inverter is correctly installed according to the following list. Any incorrect installation would require a risk assessment.

Check List

1. The inverter installation should be protected by shelter from direct sunlight or bad weather such as snow, rain, or lightning.
2. The inverter should be installed on a solid surface that is suitable for the inverter’s dimensions and weight.
3. The inverter should be installed vertically or at a maximum back tilt of 15°. Leave enough space around the inverter according to the figure below.



4. The inverter should be installed in an environment with good ventilation and heat dissipation conditions.
5. The ambient temperature should be between -25°C and 45°C. High ambient temperatures will cause power derating of the inverter.
6. The relative humidity should be less than 95%, without condensing.
7. The inverter should be installed at eye level for convenient maintenance.
8. The product label on the inverter should be visible after installation.
9. The inverter should be installed far from flammable materials.

3.3.2 Mounting Inverter

Install the inverter on the wall using the provided wall-mounting bracket and expansion plug sets.

Procedure	
<p>Step 1&2</p>	<ul style="list-style-type: none"> Position the bracket against the wall and mark the 6 drilling hole locations. Drill holes with a driller, and make sure the holes are deep enough (at least 60 mm).
<div style="display: flex; justify-content: space-around;"> <div data-bbox="408 465 667 719"> </div> <div data-bbox="946 465 1204 719"> </div> </div>	
<p>Step 3&4</p>	<ul style="list-style-type: none"> Place sleeves in the holes, and then tighten them. Fix the wall bracket with expansion screws. Please confirm that the bracket is firmly attached to the mounting surface.
<div style="display: flex; justify-content: space-around;"> <div data-bbox="408 958 667 1211"> </div> <div data-bbox="946 958 1204 1211"> </div> </div>	
<p>Step 5&6</p>	<ul style="list-style-type: none"> Mount the inverter on the bracket. Tighten the screw with a torque of 1.4 N·m to secure the bracket and the inverter.
<div style="display: flex; justify-content: space-around;"> <div data-bbox="408 1406 667 1659"> </div> <div data-bbox="946 1406 1204 1659"> </div> </div>	

3.4 Electrical Connection

 <p>WARNING</p>	<ul style="list-style-type: none"> Before any electrical connections, keep in mind that the inverter has dual power supplies. It is mandatory for the qualified personnel to wear personal protective equipment (PPE) during the electrical work.
---	--

3.4.1 Recommended Cable List

This data is the cable specification recommended by Hoymiles, and for proper cable specification, please refer to local laws and regulations and actual installation.

Cable (90°C/194°F, Copper)	Specification			Stripping Length
	HYS-8.0LV-EUG2	HYS-10.0LV-EUG2	HYS-12.0LV-EUG2	
Ground Cable	4 AWG (25 mm ²)	4 AWG (25 mm ²)	4 AWG (25 mm ²)	12-14 mm
PV Cable	10-8 AWG (6-10 mm ²)	10-8 AWG (6-10 mm ²)	10-8 AWG (6-10 mm ²)	13-14 mm
Battery Cable	1/0-2/0 (50-70 mm ²)	2/0-3/0 (70-95 mm ²)	3/0-4/0 (95-120 mm ²)	20-23 mm
GRID L/N Cable	4-2 AWG (25-35 mm ²)	4-2 AWG (25-35 mm ²)	4-2 AWG (25-35 mm ²)	17-18 mm
GRID PE Cable	6 AWG (16 mm ²)	6 AWG (16 mm ²)	6 AWG (16 mm ²)	10-12 mm
EPS L/N/PE Cable	10-8 AWG (6-10 mm ²)	8-6 AWG (10-16 mm ²)	8-6 AWG (10-16 mm ²)	17-18 mm
GEN L/N/PE Cable	10-8 AWG (6-10 mm ²)	8-6 AWG (10-16 mm ²)	8-6 AWG (10-16 mm ²)	17-18 mm
Communication Cable	24 AWG (0.2 mm ²)	24 AWG (0.2 mm ²)	24 AWG (0.2 mm ²)	8 mm

3.4.2 Opening the Wiring Box Cover

Procedure	
Step 1	<ul style="list-style-type: none"> Loosen but do not remove the 6 screws of the wiring box cover with T20 screwdriver.
Step 2	<ul style="list-style-type: none"> Remove the cover.

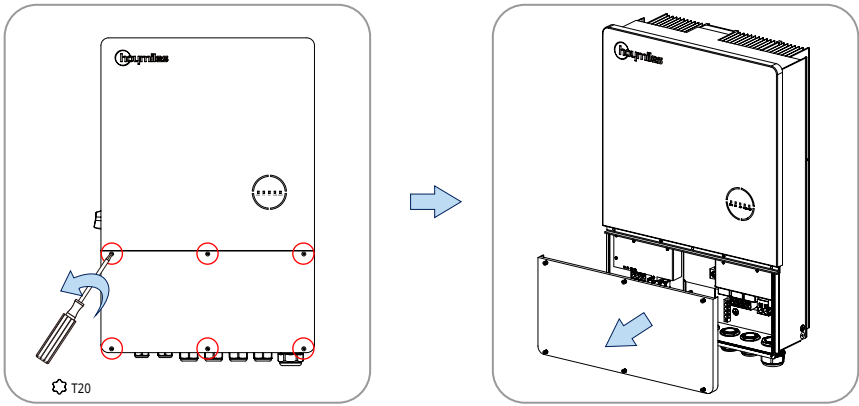

3.4.3 Ground Cable Connection

Cable (90°C/194°F, Copper)	Specification			Stripping Length
	HYS-8.0LV-EUG2	HYS-10.0LV-EUG2	HYS-12.0LV-EUG2	HYS-8.0/10.0/12.0LV-EUG2
Ground Cable	4 AWG (25 mm ²)	4 AWG (25 mm ²)	4 AWG (25 mm ²)	12-14 mm

Procedure	
Step 1	<ul style="list-style-type: none"> Crimp the cable and ground terminal.
Step 2	<ul style="list-style-type: none"> Use the screw from the accessory box to fasten the cable with the Phillips screwdriver.

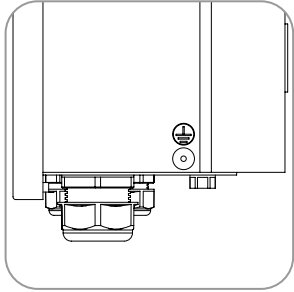
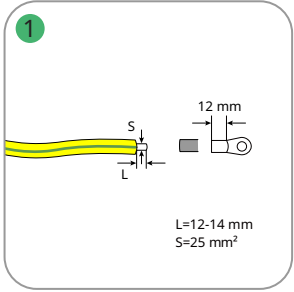
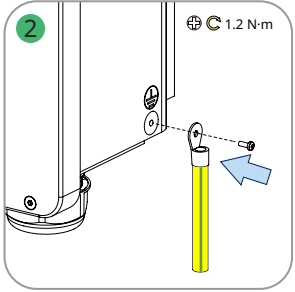
3.4.4 PV Cable Connection



WARNING

Before connecting the PV cable, please make sure all requirements listed below are followed.

- The voltage, current, and power ratings of the panels to be connected are within the allowable range of the inverter. Ensure the polarity is correct, and please refer to the technical parameters in Chapter 5 for voltage and current limits.
- If the PV cables are reversely connected or if the inverter is not working properly, do not turn off the DC switch. Otherwise, it may cause a DC arc, fire, or damage to the inverter. After the PV input current drops below 0.5 A, disconnect the DC switch and adjust the polarity of the PV strings.
- Since the inverter is a transformerless structure, please do not ground the outputs of PV panels.

Cable (90°C/194°F, Copper)	Specification			Stripping Length
	HYS-8.0LV-EUG2	HYS-10.0LV-EUG2	HYS-12.0LV-EUG2	HYS-8.0/10.0/12.0LV-EUG2
PV Cable	10-8 AWG (6-10 mm ²)	10-8 AWG (6-10 mm ²)	10-8 AWG (6-10 mm ²)	13-14 mm

Procedure	
Step 1	<ul style="list-style-type: none"> Strip the cable insulation by 13-14 mm.
Step 2	<ul style="list-style-type: none"> First insert the PV cable into the terminals according to positive and negative polarity, and then gently pull the cables backward to ensure that they are firmly connected.

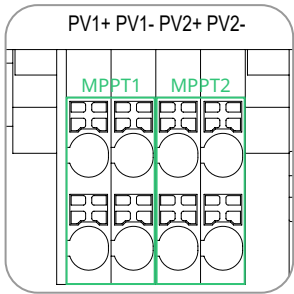
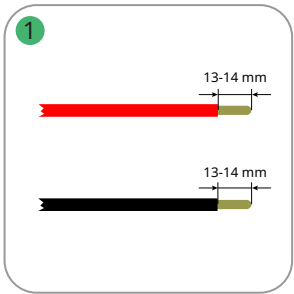
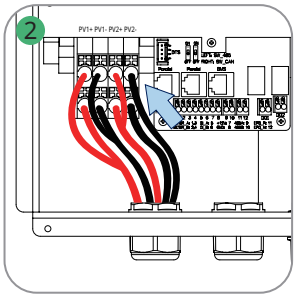





3.4.5 Battery Cable Connection

This section mainly describes the cable connections on the inverter side. Refer to the instructions supplied by the battery manufacturer for the connections on the battery side.

For batteries without a built-in DC breaker, make sure that an external DC breaker is connected.

If you need to use this hybrid inverter as a grid-tied inverter, please contact Hoymiles for help.

 WARNING	<ul style="list-style-type: none"> A two-pole DC breaker with an overcurrent protection (OCP) function is compulsory to be installed between the inverter and battery. The battery may have this switch integrated. If not, an external DC switch of proper ratings should be used. Make sure the breaker mentioned above is in the "OFF" position. Before proceeding to the next step, make sure that the battery voltage is 0 Vdc through a multimeter.
 NOTICE	<ul style="list-style-type: none"> Do not turn the battery switch on until all cables are properly connected. The inverter is compatible with specific batteries. For battery models that this inverter supports, please refer to the Hoymiles compatible battery list.

Cable (90°C/194°F, Copper)	Specification			Stripping Length
	HYS-8.0LV-EUG2	HYS-10.0LV-EUG2	HYS-12.0LV-EUG2	
Battery Cable	1/0-2/0 (50-70 mm ²)	2/0-3/0 (70-95 mm ²)	3/0-4/0 (95-120 mm ²)	20-23 mm

Procedure	
Step 1	<ul style="list-style-type: none"> Strip the battery cable insulation by 20-23 mm.
Step 2	<ul style="list-style-type: none"> Use the hex wrench to unscrew the bolts, insert the battery cables into the terminals, and then tighten the bolts. Gently pull the battery cables backward to ensure that they are firmly connected.

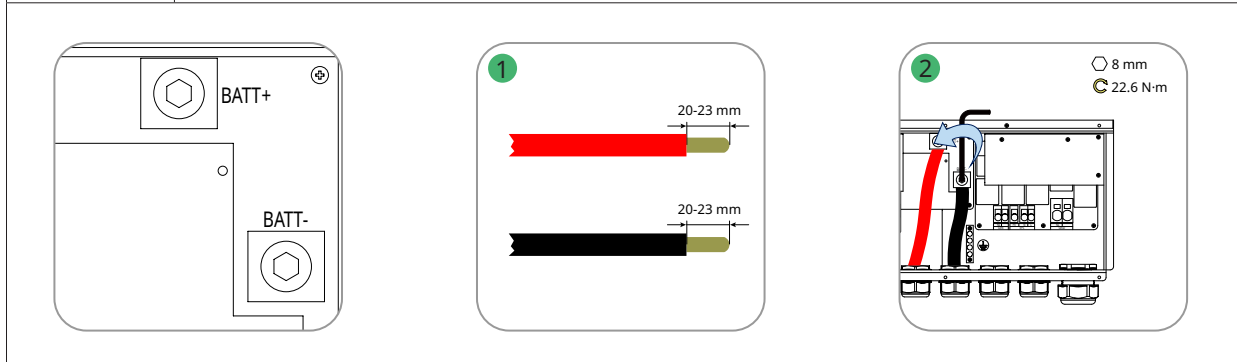

3.4.6 AC Cable Connection

The following diagrams are examples of connecting grid cables. The GEN and EPS connection methods are similar to the grid connection. For the cable specifications of GEN and EPS, please refer to the following cable specification list.

 <p>WARNING</p>	<p>Before connecting the AC cables, please make sure all requirements listed below are followed.</p> <ul style="list-style-type: none"> • An independent one or two circuit breaker must be installed on the output side of the inverter to ensure safe disconnection from the grid. • Multiple inverters cannot share one circuit breaker. • Never connect a load between the inverter and the circuit breaker. • Make sure that the overcurrent protection devices (OCPDs) (breakers) are turned off. • Before proceeding to the next step, make sure that the AC voltages are 0 Vac through a multimeter.
--	---

Cable (90°C/194°F, Copper)	Specification			Stripping Length
	HYS-8.0LV-EUG2	HYS-10.0LV-EUG2	HYS-12.0LV-EUG2	
GRID L/N Cable	4-2 AWG (25-35 mm ²)	4-2 AWG (25-35 mm ²)	4-2 AWG (25-35 mm ²)	17-18 mm
GRID PE Cable	6 AWG (16 mm ²)	6 AWG (16 mm ²)	6 AWG (16 mm ²)	10-12 mm
EPS L/N/PE Cable	10-8 AWG (6-10 mm ²)	8-6 AWG (10-16 mm ²)	8-6 AWG (10-16 mm ²)	17-18 mm
GEN L/N/PE Cable	10-8 AWG (6-10 mm ²)	8-6 AWG (10-16 mm ²)	8-6 AWG (10-16 mm ²)	17-18 mm

Procedure	
Step 1	<ul style="list-style-type: none"> • Strip the grid L/N cable insulation by 17-18 mm. • Strip the grid PE cable insulation by 10-12 mm.
Step 2	<ul style="list-style-type: none"> • Firstly, use the slotted screwdriver to unscrew the screw on the grounding bar, insert the grid PE cable, and tighten the screw. Secondly, insert the slotted screwdriver into the terminal to press down the leaf spring, insert the L/N cable into the grid terminals, and then remove the screwdriver. Gently pull the grid L/N/PE cables backward to ensure that they are firmly connected.

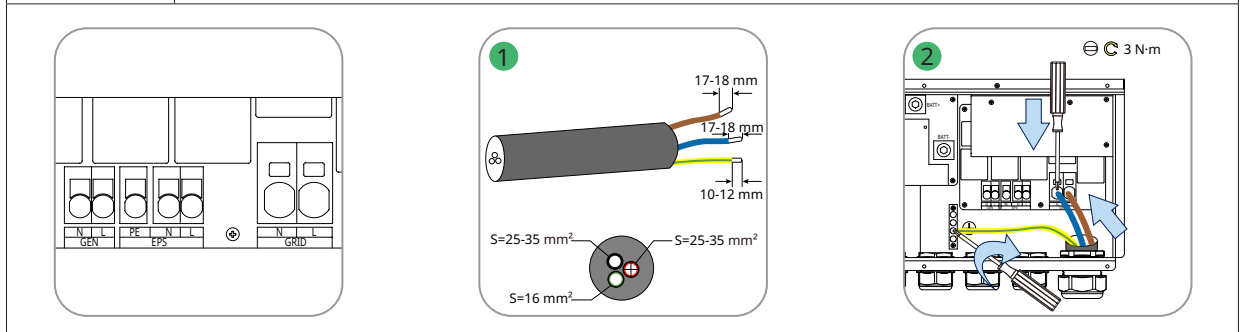

3.4.7 Communication Cable Connection

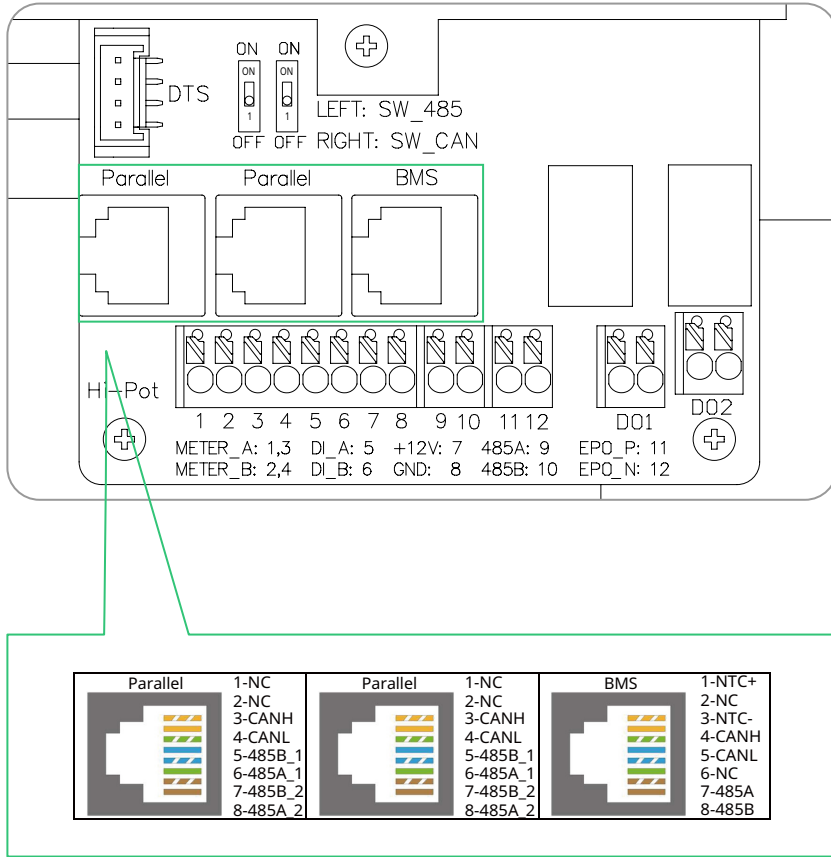

Detailed pin functions of each port on the communication interface are as follows.



Label	Description
Parallel (CANH, CANL, 485B_1, 485A_1, 485B_2, 485A_2)	For parallel operation.
BMS (NTC+, NTC-, CANH, CANL, 485A, 485B)	For Li-ion batteries, communication is via CAN or RS485. For lead-acid batteries, the temperature is monitored via a sensor through NTC+ and NTC-.
SW_485 (ON, OFF)	120 Ohm termination resistor for parallel operation.
SW_CAN (ON, OFF)	120 Ohm termination resistor for parallel operation.
Meter (485A1, 485B1, 485A2, 485B2)	For the smart meter. One is connected to the grid side, and the other is connected to the third-party inverter.
DI (DI_A, DI_B)	Dry contact input of external bypass contactor.
+12V / GND	Reserved.
EPO_P / EPO_N	For external Emergency Power Off switch.
DO1 (NO1, COM1)	Dry contact output. The DO1 can be set to one of the functions as follows: Earth Fault Alarm, Load Control, and Generator Control.
DO2 (NO2, COM2)	Dry contact output. The DO2 will control the bypass contactor under certain logic.

3.4.7.1 Smart Meter and CT Connection

The smart meter and CT in the accessory box are necessary for system installation and are used to provide the operating condition of the inverter via RS485 communication.

 WARNING	<ul style="list-style-type: none"> Before connecting the smart meter and CT, ensure that the AC cable is totally isolated from the AC power source.
 NOTICE	<ul style="list-style-type: none"> One smart meter can be used with only one inverter. One CT must be used for one smart meter and must be connected to the same phase with the smart meter power cable. There is a symbol (arrow) or label on the surface of CT that indicates the correct mechanical orientation of the CT on the conductor under measurement. Please identify the arrow or label before installing the CT.

Cable (90°C/194°F, Copper)	Specification			Stripping Length
	HYS-8.0LV-EUG2	HYS-10.0LV-EUG2	HYS-12.0LV-EUG2	HYS-8.0/10.0/12.0LV-EUG2
Communication Cable	24 AWG (0.2 mm ²)	24 AWG (0.2 mm ²)	24 AWG (0.2 mm ²)	8 mm

Procedure	
Step 1	<ul style="list-style-type: none"> Clamp CT to the L wire, respectively connect the white and blue wire of CT to terminals 5/6. The arrow on the surface of CT should point to the grid.
Step 2	<ul style="list-style-type: none"> Connect grid L/N to meter's terminals 3/4.
Step 3	<ul style="list-style-type: none"> Respectively connect meter's terminal 24/25 to inverter METER_A and METER_B.

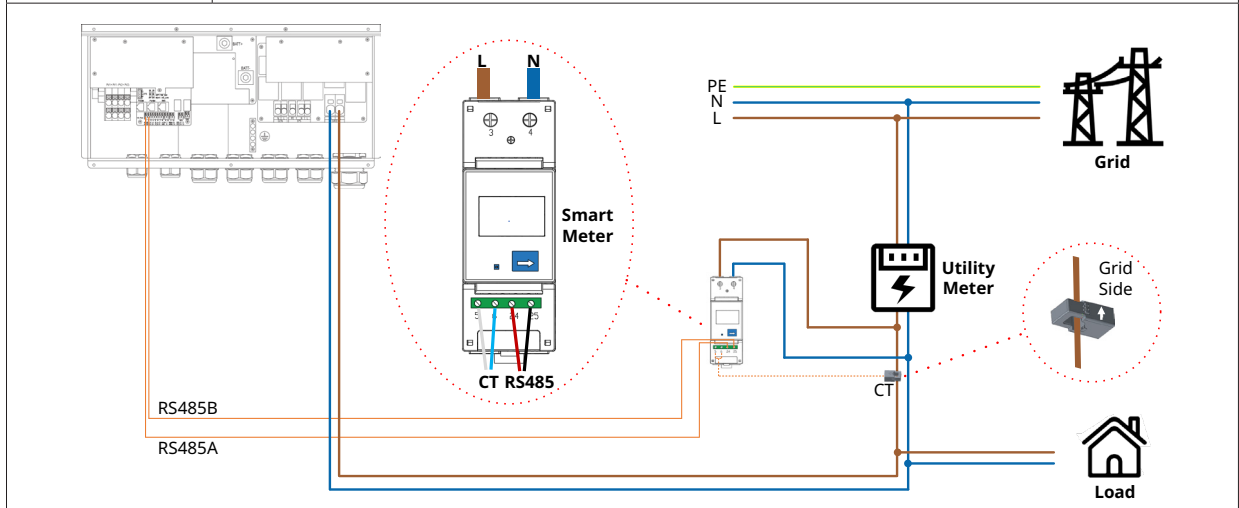

3.4.7.2 DI Connection

There is an integrated DI (DI_A, DI_B) as the dry contact input to the bypass contactor of the inverter.

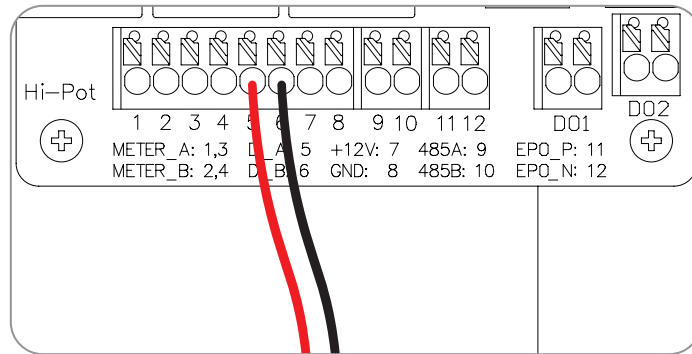

3.4.7.3 DO Connection

The inverter has integrated a multiple-function dry contact (DO1 and DO2). The DO1 can be set to one of the functions as follows, Earth Fault Alarm, Load Control, and Generator Control. The DO2 can control the external bypass contactor if installed.

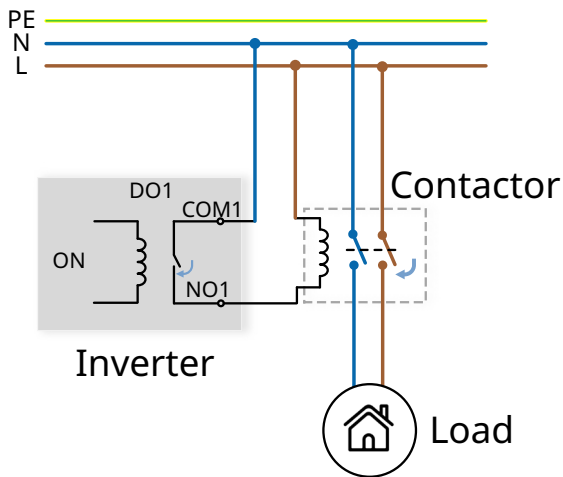
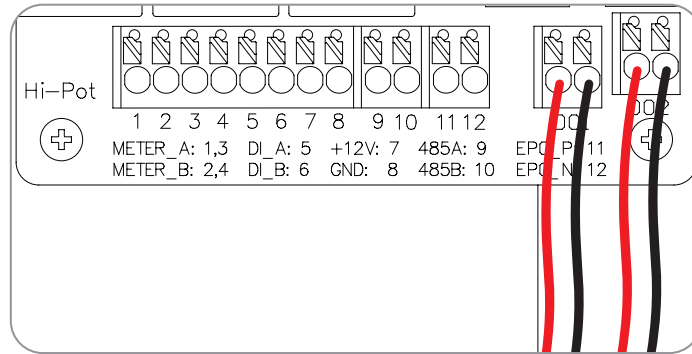

DO1-Load Control

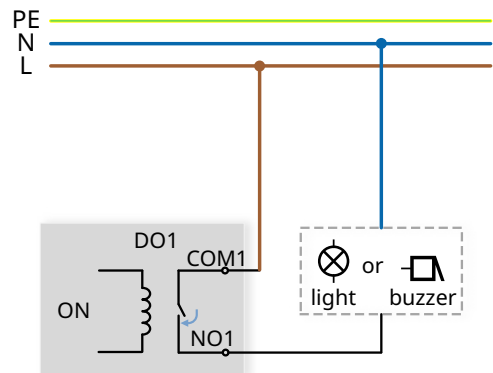

Inverter

DO1-Earth Fault Alarm

3.4.7.4 External Emergency Power Off Switch Connection (Optional)

An external Emergency Power Off (EPO) switch can be installed to shut down the system in case of emergency if needed.

The external EPO switch is not provided by Hoymiles and should be purchased separately. It must meet the requirements as follows,

- An ON/OFF position and an ON/OFF position indicator;
- A protection degree of NEMA 3R or above;
- The installation location should be readily accessible.

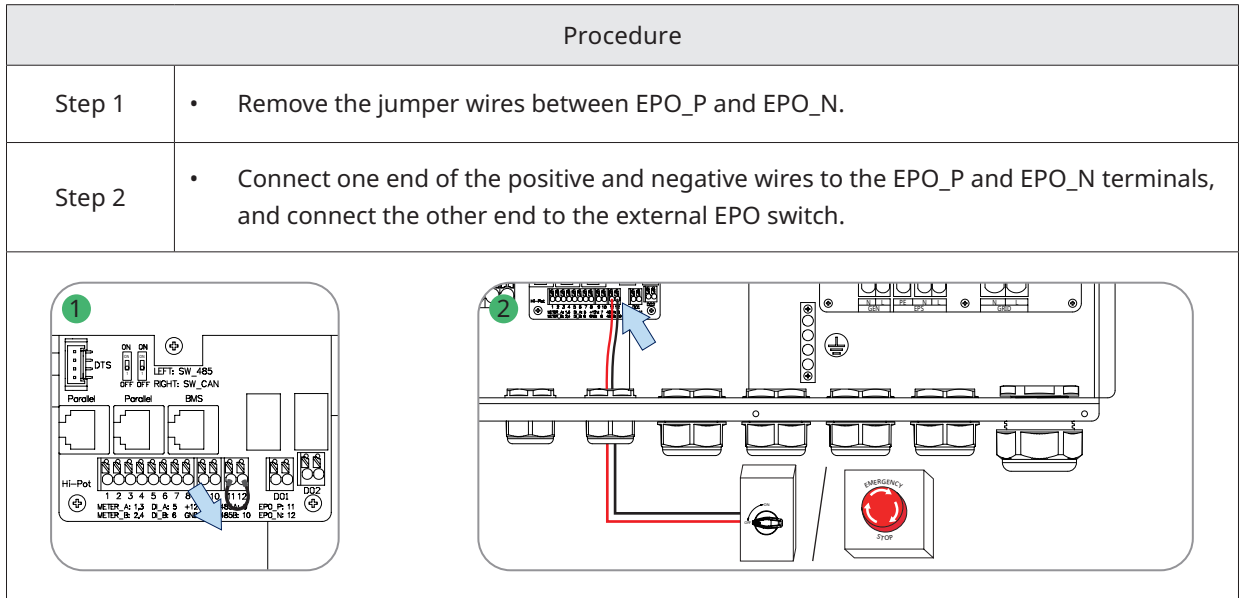

Note:

If an external Emergency Power Off switch is not needed, please do not remove the jumper wires.

3.4.7.5 BMS Connection

BMS is used to communicate with compatible Li-ion batteries. If the lead-acid battery is used to work with this inverter, the battery temperature sensor in the packing list shall be used to monitor the battery temperature.

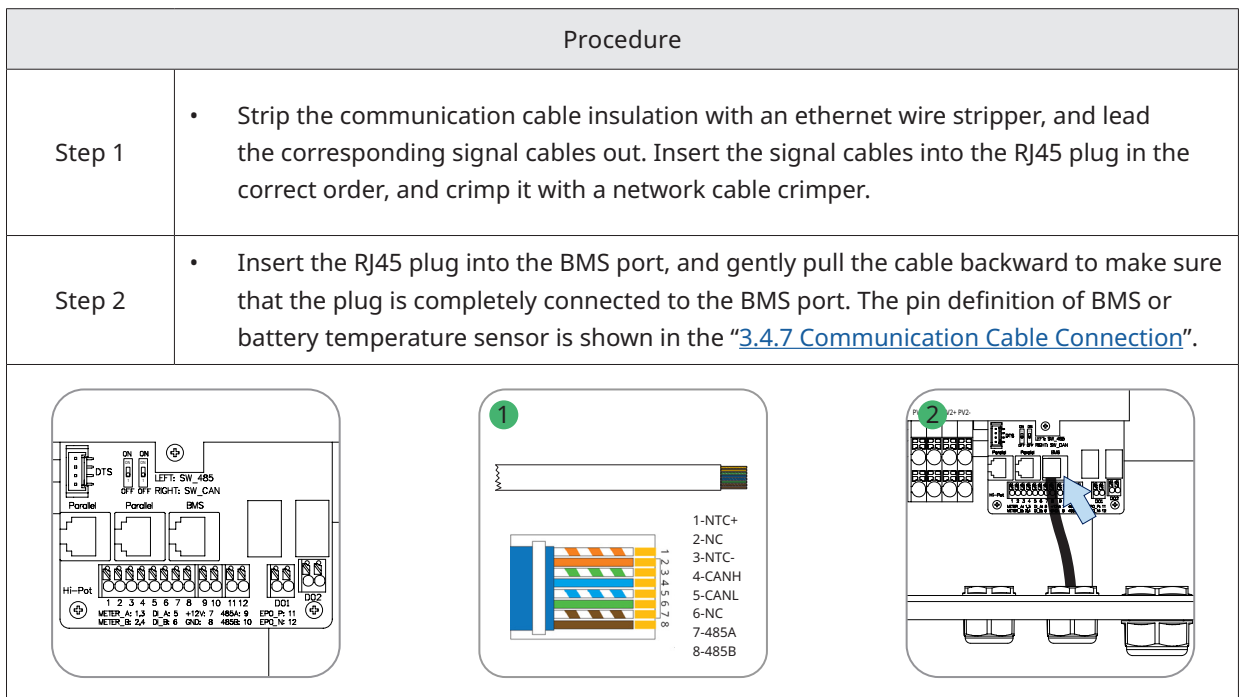

3.4.7.6 DTS Connection

DTS-4G-G1 and DTS-Wi-Fi-G1 Procedure	
Step 1	<ul style="list-style-type: none"> Remove the DTS port cover plate.
Step 2	<ul style="list-style-type: none"> Insert the DTS into the DTS port, and tighten the screws.
Step 3	<ul style="list-style-type: none"> Respectively connect the ends of the DTS connecting line to the corresponding ports.

DTS-Ethernet-G1 Procedure	
Step 1&2	<ul style="list-style-type: none"> Remove the DTS port cover plate. Insert the DTS-Ethernet into the DTS port, and tighten the screws.
Step 3&4	<ul style="list-style-type: none"> Respectively connect the ends of the DTS connecting line to the corresponding ports. Unscrew the swivel nut from the connector.
Step 5	<ul style="list-style-type: none"> Insert the RJ45 plug (pin definition is shown below) into the connector until there is an audible click sound. (Note that the RJ45 plug with cable sheath cannot be inserted.) Thread the cable of an appropriate length through the connector. Tighten the cable gland.

Indicator	Status	Description
RUN	ON	DTS is powered on.
	OFF	DTS is not powered on.
COM	ON	Proper communication with the inverter.
	OFF	Improper communication with the inverter.
NET	ON	Proper communication with S-Miles Cloud.
	OFF	Improper communication with S-Miles Cloud.
	BLINK	Improper communication with S-Miles Cloud, but the network is connected.

3.4.8 Installing the Wiring Box Cover

Procedure
<ul style="list-style-type: none"> After the cables are firmly and correctly connected, install the wiring box cover with a T20 screwdriver.
<p>The diagram illustrates the two-step process of installing the wiring box cover. On the left, a white rectangular cover is shown being pushed into the bottom compartment of the inverter. On the right, the cover is fully seated, and a T20 screwdriver is shown tightening the screws around its perimeter. Red circles highlight the screw locations. A legend at the bottom right of the right-hand image specifies 'T20' and '1.2 N-m'.</p>

3.5 Operation

3.5.1 Commissioning

	<p>Before the commissioning of the inverter, make sure:</p> <ul style="list-style-type: none"> • The inverter DC switch and external circuit breaker are disconnected; • Check wiring according to “3.4 Electrical Connection”; • Check whether the grid voltage is within the permissible range through the multimeter before turning on the AC switch; • Unused terminals must be sealed using corresponding sealing plugs; • Nothing is left on the top of the inverter and battery; • Cables are routed in a safe place or protected against mechanical damage; • Warning signs and labels are intact.
---	---

System Power-on Procedure	
Step 1	If the inverter is connected to the battery, turn on the battery power switch and DC breaker.
Step 2	Turn on the AC breaker between the inverter and the grid.
Step 3	Rotate the DC switch to “ON” if the inverter is connected to the PV strings.
Step 4	Check whether the inverter is operating properly through the inverter indicators status.

3.5.2 Decommissioning

	<p>After powering off the inverter, follow the steps below if needed:</p> <ul style="list-style-type: none"> • Wait at least 5 minutes after the LED indicators turn off to release the internal energy; • Disconnect all cables; • Remove DTS and power meter; • Remove the inverter from the wall, and remove the bracket if necessary, and finally pack the inverter and accessories; <p>Please strictly follow the procedure below. Otherwise, it will cause lethal voltages or unrecoverable damage to the inverter.</p>
---	---

System Power-off Procedure	
Step 1	Stop the inverter from working via the Hoymiles App.
Step 2	Disconnect the AC breaker between the inverter and the grid.
Step 3	Rotate the DC switch to “OFF” if the inverter is connected to the PV strings.
Step 4	Turn off the DC breaker between the inverter and the battery.
Step 5	Check whether the inverter indicators are off.

3.5.3 S-Miles Cloud App

The S-Miles Cloud App has been developed for the Hoymiles inverter and offers the following features:

- a. Network configuration;
- b. Local installation assistant;
- c. System monitoring.

Please download the S-Miles Cloud App from the Google Play Store or the Apple App Store. The QR code below can also be scanned to download the App. Please refer to the S-Miles Cloud User Manual from www.hoymiles.com/resources/download/ for details.



S-Miles Installer



S-Miles End-user

3.5.3.1 DTS Online Setting

1. Search “Hoymiles” in the App Store (iOS) or the Play Store (Android), or scan the QR code to download the Hoymiles Installer App.
2. Open the app and log in with your installer account and password. For new Hoymiles installers, please apply for an installer account from your distributor in advance.
3. Use the App to connect to the DTS.
 - (a) Open the Installer App on smartphone/tablet and log in. Tap on “O&M” at the bottom of the page, and then tap on “Network Config”.

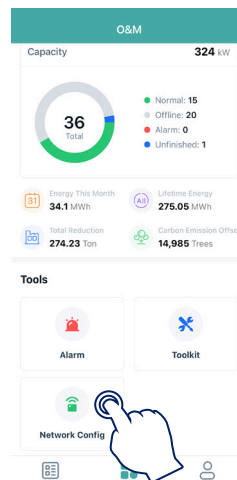
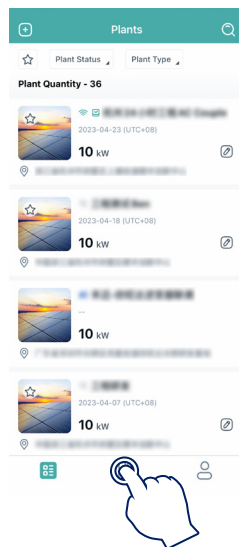

(b) Select the DTS's wireless network and tap "Connect". (The network name of the DTS consists of DTS and product serial number, and the default password is ESS12345.)

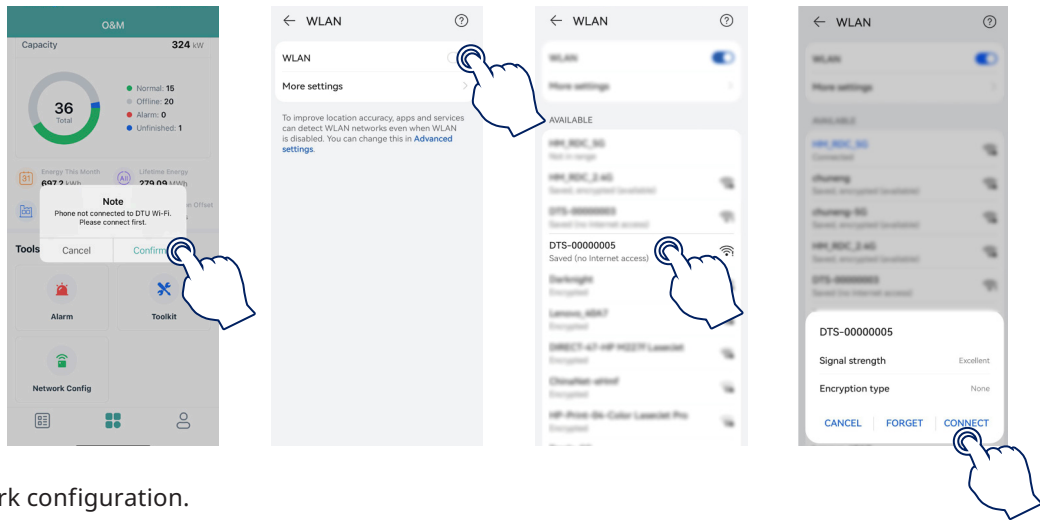

4. Network configuration.

- (a) Upon successful connection, tap on "Network Config" again and access the Network Configuration page.
- (b) Select the router Wi-Fi and enter the password.
- (c) Tap on "Send to DTU".

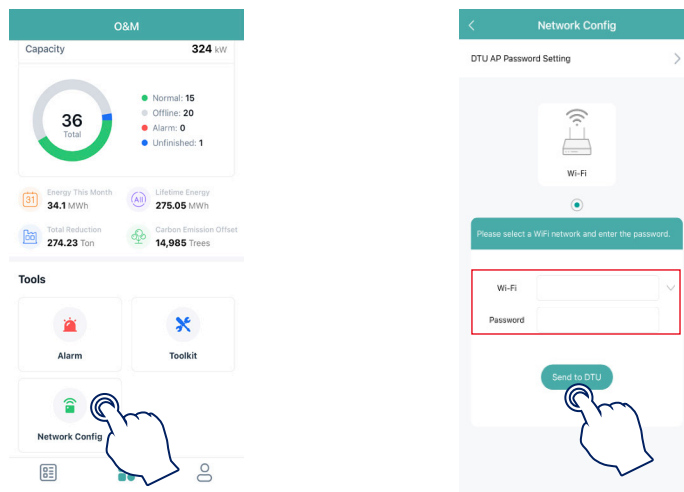

5. Check the DTS indicator for a solid blue light, which signifies a successful connection. The network configuration takes about 1 minute, please be patient. If the network is not connected, please check the internet as instructed.

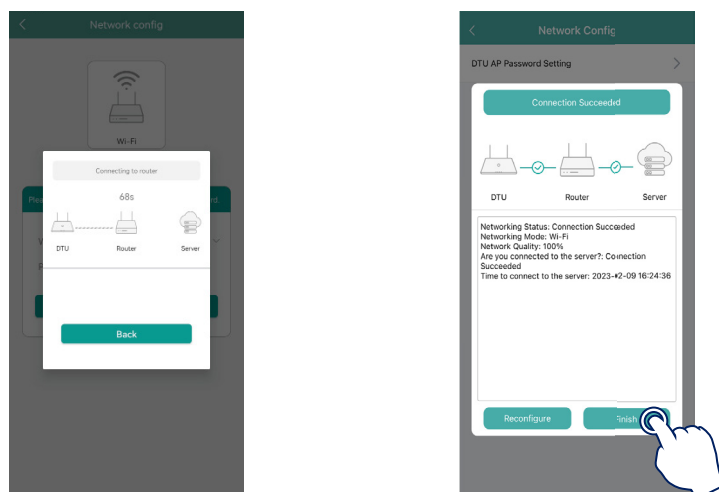

3.5.3.2 System Commissioning of Wireless Access Point (AP) Connection

1. Connect the wireless network of DTU. Open the App, and tap “Toolkit → Meter Location” to configure the grid side meter. The serial number (SN) can be entered manually or identified through scanning the QR code.

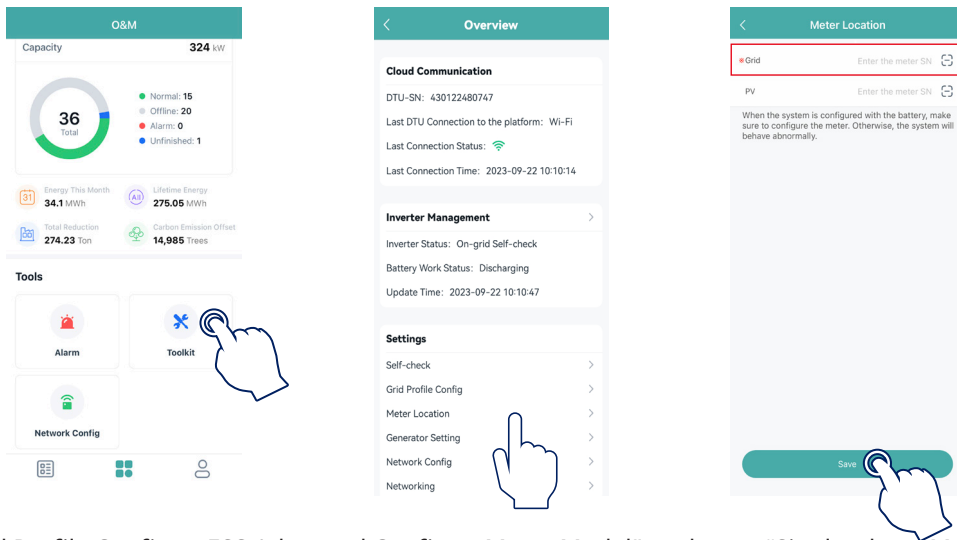

2. Tap “Grid Profile Config → ESS Advanced Config → Meter Model” to choose “Single-phase Meter”, and tap “Save”.

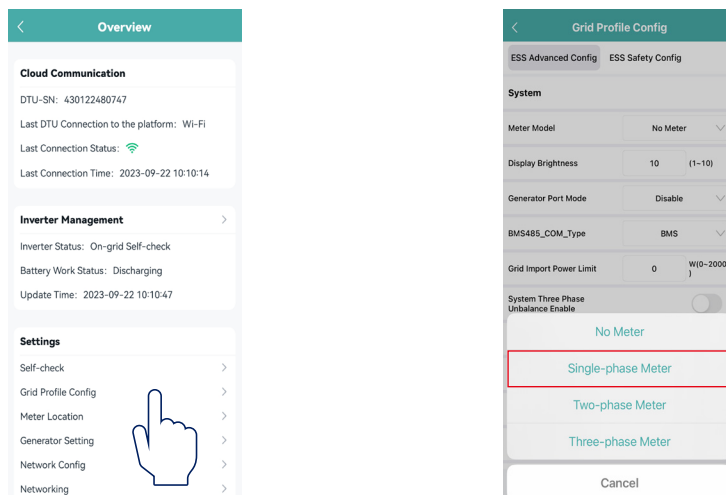

3. Tap “Inverter Management → Battery Setting” to set battery type, BMS protocol, and battery capacity, and tap “Save”. (The default setting is “No battery”).

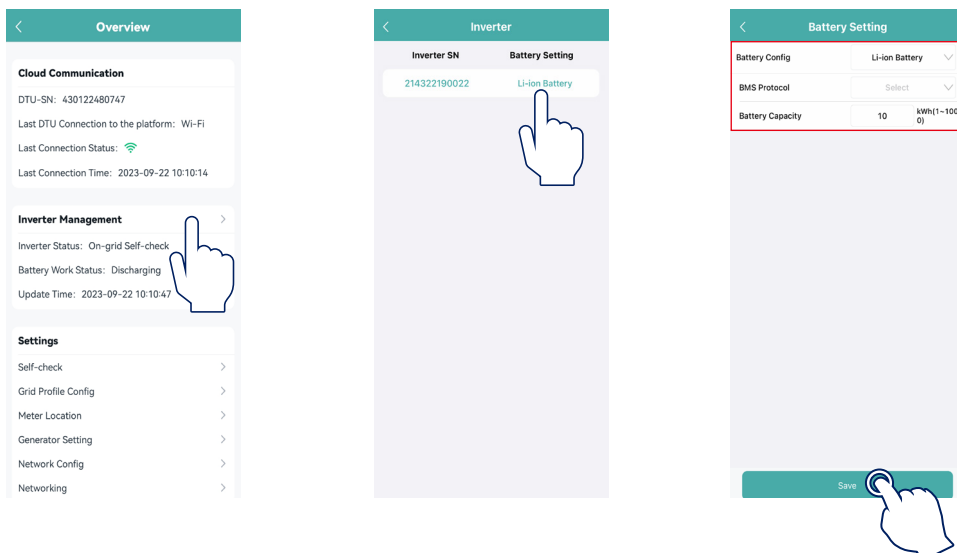

4. Tap “Generator Setting”, choose the corresponding option according to whether the device connected to the GEN port is “Generator” or “Inverter”, and click “Save”. (The default option is “None”.)

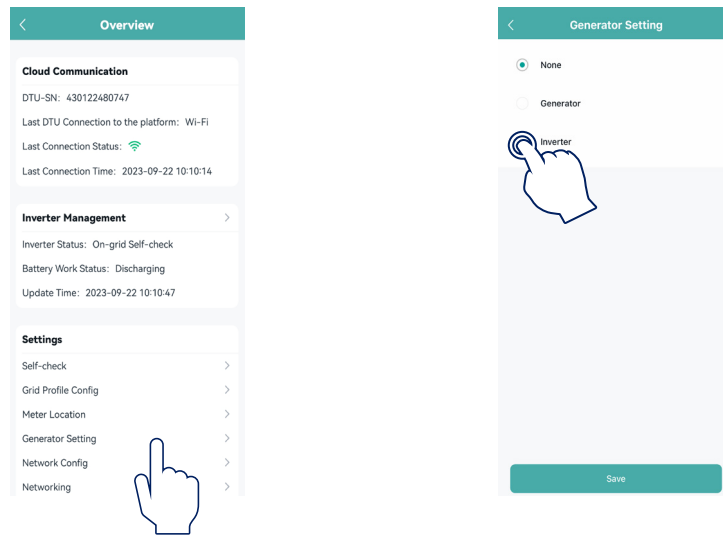

5. Make sure that all cables including DC cables, AC cables, and communication cables are properly connected, and all DC and AC switches are turned on, and then tap “Self-check”. If there is any problem, solve the problem, and tap “Self-check” again to confirm that the problem is completely solved. If there is no problem, this interface will display green checkmarks on the right of these items.

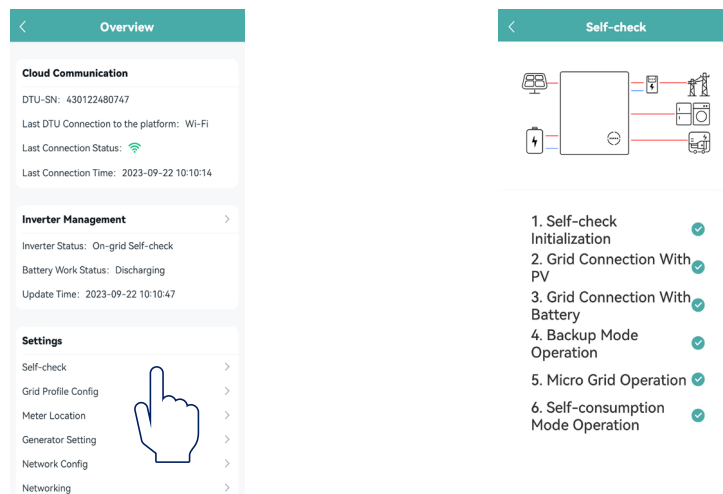

4. Troubleshooting

When the system is in alarm, please log into the S-Miles Cloud App to review. The possible causes and their troubleshooting are detailed in the following table.

Display	Possible Cause	Handling Suggestions
Grid Overvoltage	The grid voltage is higher than the permissible range.	Generally, the inverter will reconnect to the grid after the grid recovers. If the alarm occurs frequently: 1. Make sure the ESS safety configuration of the inverter is set correctly. 2. Make sure that the grid voltage in your area is stable and within the normal range. 3. Check whether the cross-sectional area of the AC cable meets the requirement. 4. If the alarm persists, contact Hoymiles technical support team.
Grid Undervoltage	The grid voltage is lower than the permissible range.	Generally, the inverter will reconnect to the grid after the grid recovers. If the alarm occurs frequently: 1. Make sure the ESS safety configuration of the inverter is set correctly. 2. Make sure that the grid voltage in your area is stable and within the normal range. 3. Check whether the AC cable is firmly in place. 4. If the alarm persists, contact Hoymiles technical support team.
Grid Overfrequency	The grid frequency is higher than the permissible range.	Generally, the inverter will reconnect to the grid after the grid recovers. If the alarm occurs frequently: 1. Make sure the ESS safety configuration of the inverter is set correctly. 2. Make sure that the grid frequency in your area is stable and within the normal range. 3. If the alarm persists, contact Hoymiles technical support team.
Grid Underfrequency	The grid frequency is lower than the permissible range.	
No Grid	The inverter detects that there is no grid connected.	Generally, the inverter will reconnect to the grid after the grid recovers. If the alarm occurs frequently: 1. Check whether the grid supply is reliable. 2. Check whether the AC cable is firmly in place. 3. Check whether the AC cable is correctly connected. 4. Check whether the AC circuit breaker is disconnected. 5. If the alarm persists, contact Hoymiles technical support team.
Residual Current Fault	The residual leakage current is too high.	1. The alarm can be caused by high ambient humidity, and the inverter will reconnect to the grid after the environment is improved. 2. If the environment is normal, check whether the AC and DC cables are well insulated. 3. If the alarm persists, contact Hoymiles technical support team.
PV Reverse Connection	The inverter detects that the PV strings are reversely connected.	1. Check whether the corresponding string is of reverse polarity. If so, disconnect the DC switch and adjust the polarity when the string current drops below 0.5 A. 2. If the alarm persists, contact Hoymiles technical support team.
PV Undervoltage	The PV voltage is lower than the permissible range.	1. Check whether the DC cable is firmly in place. 2. Check whether there is a PV module shaded. If so, remove the shade and ensure the PV module is clean. 3. Check whether the PV module is in abnormal aging. 4. If the alarm persists, contact Hoymiles technical support team.
PV Overvoltage	The PV voltage is higher than the permissible range.	1. Check the specification and numbers of corresponding string PV modules. 2. If the alarm persists, contact Hoymiles technical support team.

Display	Possible Cause	Handling Suggestions
Over Temperature	The temperature inside the inverter is higher than the permissible range.	<ol style="list-style-type: none"> 1. Make sure that the installation complies with the instructions from the User Manual. 2. Check whether the alarm "Fan Fault" occurs. If so, replace the faulty fan. 3. If the alarm persists, contact Hoymiles technical support team.
Isolation Fault	The insulation impedance of the PV string to the ground is too low.	<ol style="list-style-type: none"> 1. Use a multimeter to determine if the resistance between the earth and the inverter frame is close to zero. If not, please ensure that the connection is good. 2. If the humidity is too high, an isolation fault may occur. Attempt to restart the inverter. If the fault persists, check it again when the weather turns fine. 3. Check the resistance to ground from the PV module/ cable. Take corrective measures in case of leading to a short circuit or damaged insulation layer. 4. If the alarm persists, contact Hoymiles technical support team.
Arc Fault	The inverter detects that there is an arc fault.	<ol style="list-style-type: none"> 1. Disconnect the DC switch and check whether the DC cables are damaged and whether the wiring terminals are loose or in poor contact. If so, take corresponding corrective measures. 2. After taking corresponding measures, reconnect the DC switch. 3. If the alarm persists, contact Hoymiles technical support team.
EPS Load Overpower	The EPS load power is higher than the permissible range.	<ol style="list-style-type: none"> 1. Reduce the power of EPS loads, or remove some EPS loads. The inverter will restart automatically. 2. If the alarm persists, contact Hoymiles technical support team.
Meter Reverse Connection	The inverter detects that the Meter or CT is reversely connected.	<ol style="list-style-type: none"> 1. Make sure that the installation complies with the instructions from the User Manual. 2. If the alarm persists, contact Hoymiles technical support team.
Meter Communication Fault	The inverter detects that there is a meter communication fault.	<ol style="list-style-type: none"> 1. Check whether the Meter communication cable and terminal are abnormal. 2. Reconnect the Meter communication cable. 3. If the alarm persists, contact Hoymiles technical support team.
Battery Reverse Connection	The inverter detects that the battery wirings are reversely connected.	<ol style="list-style-type: none"> 1. Check the battery for polarity correctness, and correct it if necessary. 2. If the alarm persists, contact Hoymiles technical support team.
Battery Voltage Fault	The battery voltage is higher than the permissible range.	<ol style="list-style-type: none"> 1. Check if the battery input voltage is within the normal range. 2. If the alarm persists, contact Hoymiles technical support team.
BMS Communication Fault	The inverter detects that there is a BMS communication fault.	<ol style="list-style-type: none"> 1. Check whether the BMS communication cable and terminal are abnormal. 2. Reconnect the BMS communication cable. 3. If the alarm persists, contact Hoymiles technical support team.

Display	Possible Cause	Handling Suggestions
BMS Battery Alarm	The inverter detects that there is a battery fault from BMS.	Try to restart the battery. If the fault persists, contact the battery manufacturer.
BMS Battery Fault	The inverter detects that there is a battery fault from BMS.	Try to restart the battery. If the fault persists, contact the battery manufacturer.
Relay Fault	The inverter detects that there is a relay self-check fault.	Try to restart the inverter. If the fault persists, contact Hoymiles technical support team.

5. Technical Datasheet

Model	HYS-8.0LV-EUG2	HYS-10.0LV-EUG2	HYS-12.0LV-EUG2
Battery			
Battery type	Li-ion/Lead-acid		
Battery voltage range (V)	40-60		
Max. charge/discharge current (A)	160/160	200/200	240/240
Max. charge/discharge power (W)	8000/8000	10000/10000	12000/12000
Charging strategy for Li-ion battery	Self-adaption to BMS		
Charging curve	3 Stages/Equalization		
External temperature sensor	Optional		
Communication	CAN, RS485		
PV Input			
Recommended max. PV power (W)	10400	13000	15600
Max. input voltage (V)	550		
Rated voltage (V)	360		
Start-up voltage (V)	150		
MPPT voltage range (V)	125-500		
Max. input current (A)	32/32	32/32	32/32
Max. short circuit current (A)	40/40	40/40	40/40
MPPT number/Max. input strings number	2/4	2/4	2/4
AC Input and Output (On-grid)			
Rated output power (W)	8000	10000	12000
Max. output apparent power (VA)	8800	11000	13200
Max. input power (W)	23000	23000	23000
Grid form	L/N/PE		
Rated AC output voltage/Range (V)	220/230, 154-276		
Rated grid frequency (Hz)	50/60		
Max. output current (A)	38.3	47.8	57.4
Max. input current (A)	100	100	100
Power factor	>0.99 (0.8 leading ... 0.8 lagging)		
THDi (@rated output)	<3%		
AC Output (Off-grid)			
Rated output power (W)	8000	10000	12000
Max. output apparent power (VA)	16000, 10s	20000, 10s	23000, 10s
Back-up switch time (ms)	<10		
Grid form	L/N/PE		
Rated output voltage (V)	220/230		
Rated output frequency (Hz)	50/60		
Max. continuous output current (A)	34.8	43.5	52.2
THDv (@linear load)	<3%		
Efficiency			
MPPT efficiency	99.9%	99.9%	99.9%
Max. efficiency	97.6%	97.6%	97.6%
EU efficiency	97.0%	97.0%	97.0%
Max. battery discharge to AC efficiency	95.0%	95.0%	95.0%
Protection			
Anti-islanding protection	Integrated		
PV string input reverse polarity protection	Integrated		
Insulation resistor detection	Integrated		
Residual current monitoring unit	Integrated		
AC over current protection	Integrated		
AC short current protection	Integrated		
AC overvoltage and undervoltage protection	Integrated		
PV arc fault detection	Optional		
Compliant MLRSD products	Optional		
Surge protection	DC Type II/AC Type III		
General			
Dimensions (W × H × D [mm])	502 × 740 × 202		
Weight (kg)	41		
Mounting	Wall Mounting		
Operating temperature (°C)	-25 to +65 (>45, derating)		
Relative humidity	0-95%, no condensing		
Cooling	Smart Cooling		
Topology (Solar/Battery)	Transformerless/High-frequency Isolation		
Altitude (m)	≤2000		
Protection degree	IP65		
Noise (dB)	<40		
User interface	LED & APP		
Digital input/output	1 × DI, 2 × DO		
Communication	RS485, Optional: Wi-Fi/WLAN/GPRS		
Certifications and Standards			
Grid connection standard	EN 50549, NRS 097-2-1		
Safety/EMC standard	IEC 62109-1/-2, IEC/EN 61000-6-1/-2/-3/-4		



S-Miles Installer

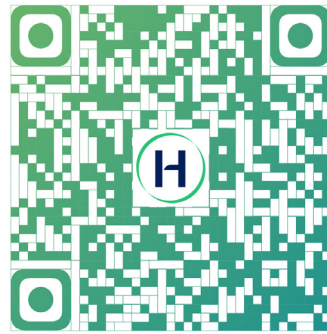

S-Miles End-user

Floor 6-10, Building 5, 99 Housheng Road, Gongshu District,
Hangzhou 310015
P. R. China
+86 571 2805 6101

General inquiry: info@hoymiles.com
Technical support: service@hoymiles.com

Visit <https://www.hoymiles.com/> for more information.