

All-in-one solar charge inverter

User Manual



Product models:

HYP4850S100-H | HYP4850U100-H

Important safety instructions

Please keep this manual for future use.

This manual contains all safety, installation and operating instructions for the HYP Series all-in-one solar charge inverter.

Please read all instructions and precautions in the manual carefully before installation and use.

- Non-safety voltage exists inside the all-in-one solar charge inverter. To avoid personal injury, users shall not disassemble the all-in-one solar charge inverter themselves. Contact our professional maintenance personnel if there is a need for repair.
- Do not place the all-in-one solar charge inverter within the reach of children.
- Do not install the all-in-one solar charge inverter in harsh environments such as moist, oily, flammable or explosive, or heavily dusty areas.
- The mains input and AC output are high voltage, so please do not touch the wiring terminals.
- The housing of the all-in-one solar charge inverter is hot when it is working. Do not touch it.
- Do not open the terminal protective cover when the all-in-one solar charge inverter is working.
- It is recommended to attach proper fuse or circuit breaker to the outside of the all-in-one solar charge inverter.
- Always disconnect the fuse or circuit breaker near the terminals of PV array, mains and battery before installing and adjusting the wiring of the all-in-one solar charge inverter.
- After installation, check that all wire connections are tight to avoid heat accumulation due to poor connection, which is dangerous.
- The all-in-one solar charge inverter is off-grid. It is necessary to confirm that it is the only input device for load, and it is forbidden to use it in parallel with other input AC power to avoid damage.

CONTENTS

1. GENERAL INFORMATION	4
1.1 PRODUCT OVERVIEW AND FEATURES	4
1.2 BASIC SYSTEM INTRODUCTION.....	5
1.3 APPEARANCE	6
1.4 DIMENSION DRAWING.....	7
2. INSTALLATION INSTRUCTIONS.....	8
2.1 INSTALLATION PRECAUTIONS.....	8
2.2 WIRING SPECIFICATIONS AND CIRCUIT BREAKER SELECTION	9
2.3 INSTALLATION AND WIRING	11
2.4 PARALLEL MACHINE WIRE CONNECTION	17
2.4.1 INTRODUCTION	17
2.4.2 PRECAUTIONS FOR CONNECTING THE PARALLEL CONNECTING LINES.....	17
2.4.3 SCHEMATIC DIAGRAM OF PARALLEL CONNECTION IN SINGLE PHASE	19
2.4.4 SCHEMATIC DIAGRAM OF PARALLEL CONNECTION IN SPILIT PHASE.....	22
2.4.5 SCHEMATIC DIAGRAM OF PARALLEL CONNECTION IN THREE PHASE	26
3. OPERATING MODES	32
3.1 CHARGING MODE	32
3.2 OUTPUT MODE	33
4. LCD SCREEN OPERATING INSTRUCTIONS.....	34
4.1 OPERATION AND DISPLAY PANEL	34
4.2 SETUP PARAMETERS DESCRIPTION	38
4.3 BATTERY TYPE PARAMETERS.....	48
5. OTHER FUNCTIONS	50
5.1 DRY CONTACT	50
5.2 RS485 COMMUNICATION PORT	50
5.3 USB COMMUNICATION PORT.....	50
5.4 PARALLEL COMMUNICATION FUNCTION (PARALLEL OPERATION ONLY)	51
5.5 CURRENT SHARING DETECTION FUNCTION (PARALLEL OPERATION ONLY)	51
6. PROTECTION	52
6.1 PROTECTIONS PROVIDED	52
6.2 FAULT CODE	54
6.3 HANDLING MEASURES FOR PART OF FAULTS	58
7.TROUBLESHOOTING.....	59
8. TECHNICAL PARAMETERS.....	60

1. General information

1.1 Product overview and features

HYP series is a new all-in-one hybrid solar charge inverter, which integrates solar energy storage & means charging energy storage and AC sine wave output. Thanks to DSP control and advanced control algorithm, it has high response speed, high reliability and high industrial standard. Four charging modes are optional, i.e. Only Solar, Mains Priority, Solar Priority and Mains & Solar hybrid charging; and two output modes are available, i.e. Inverter and Mains, to meet different application requirements.

The solar charging module applies the latest optimized MPPT technology to quickly track the maximum power point of the PV array in any environment and obtain the maximum energy of the solar panel in real time.

Through a state of the art control algorithm, the AC-DC charging module realizes fully digital voltage and current double closed loop control, with high control precision in a small volume. Wide AC voltage input range and complete input/output protections are designed for stable and reliable battery charging and protection.

Based on full-digital intelligent design, the DC-AC inverter module employs advanced SPWM technology and outputs pure sine wave to convert DC into AC. It is ideal for AC loads such as household appliances, power tools, industrial equipment, and electronic audio and video equipment. The product comes with a segment LCD design which allows real-time display of the operating data and status of the system. Comprehensive electronic protections keep the entire system safer and more stable.

Features:

1. Anti-backflow grid connection function, support for inverter and mains power hybrid output, support for use without battery, can be set up for on-grid power generation.
2. Two output modes: mains bypass and inverter output; uninterrupted power supply.
3. Available in 4 charging modes: Only Solar, Mains Priority, Solar Priority and Mains & Solar hybrid charging.
4. Advanced MPPT technology with an efficiency of 99.9%.
5. Designed with a LCD screen and 3 LED indicators for dynamic display of system data and operating status.
6. With time slot control, you can set the priority of using the mains and battery according to the time slot in conjunction with the local peak and valley tariffs.
7. Power saving mode available to reduce no-load loss.
8. Intelligent variable speed fan efficiently dissipate heat and extend system life.
9. Lithium battery activation by PV solar or mains, allowing access of lead-acid battery and lithium battery.
10. 360 ° all-around protection with a number of protection functions.
11. Complete protections, including short circuit protection, over voltage and under voltage protection, overload protection, reverse protection, etc.

1.2 Basic system introduction

The figure below shows the system application scenario of this product. A complete system consists of the following parts:

1. PV module: Convert light energy into DC power, and charge the battery through the all-in-one solar charge inverter, or directly invert into AC power to drive the load.

2. Mains or generator: Connected at the AC input, to power the load while charging the battery. If the mains or generator is not connected, the system can also operate normally, and the load is powered by the battery and PV module.

3. Battery: Provided to ensure normal power supply to the system loads when solar energy is insufficient and the Mains is not connected.

4. Household load: Allow connection of various household and office loads, including refrigerators, lamps, TVs, fans and air conditioners.

5. All-in-one solar charge inverter: The energy conversion unit of the whole system.

Specific system wiring method depends on the actual application scenario.

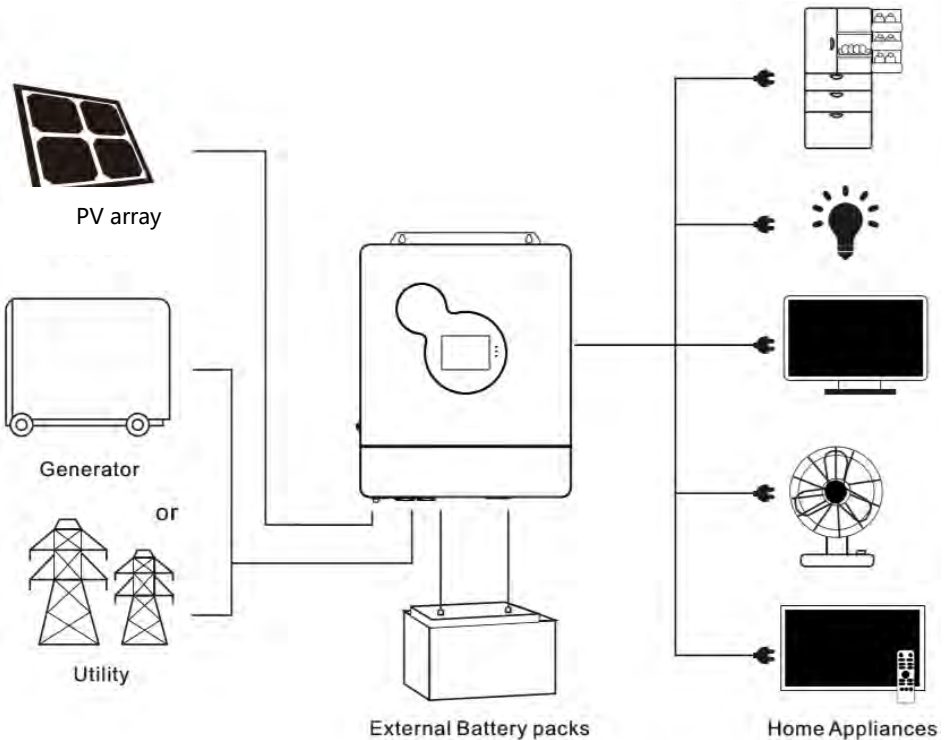

1.3 Appearance

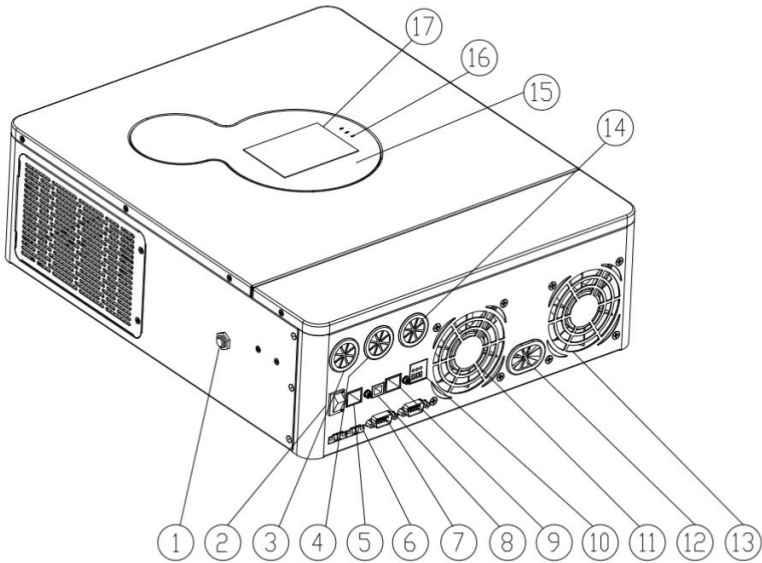

①	Overload protector	⑩	RS485-1 communication port
②	ON/OFF rocker switch	⑪	Dry contact port
③	AC input port	⑫	Cooling fan
④	AC output port	⑬	Battery port
⑤	Grounding screw hold	⑭	Cooling fan
⑥	RS485-2 communication port	⑮	PV port
⑦	Current sharing port (parallel module only)	⑯	Function key
⑧	Parallel communication port (parallel module only)	⑰	Indicator light
⑨	USB communication port	⑱	LCD screen

1.4 Dimension drawing

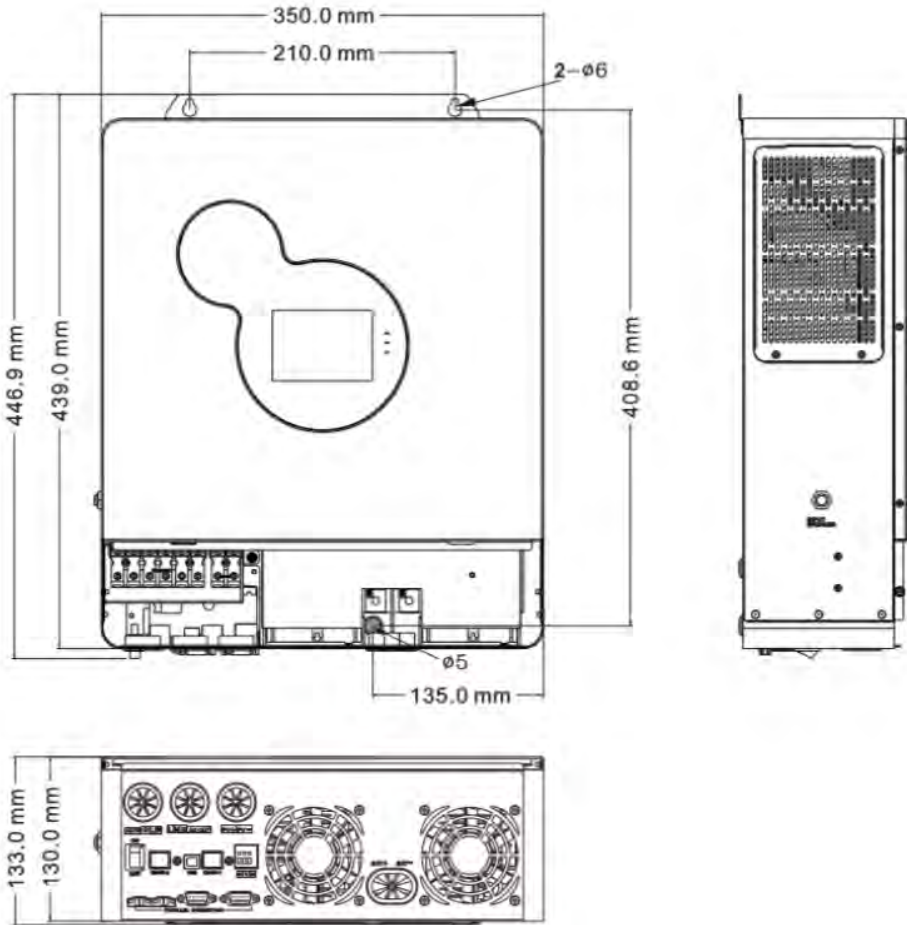

2. Installation instructions

2.1 Installation precautions

Please read this manual carefully prior to installation to familiarize yourself with the installation steps.

- Be very careful when installing the battery. Wear safety goggles when installing a lead-acid liquid battery. Once coming into contact with the battery acid, rinse with clean water timely.
- Do not place metal objects near the battery to prevent short-circuit of the battery.
- Acid gas may be generated when the battery is charged. So, please ensure good ventilation.
- When installing the cabinet, be sure to leave enough space around the all-in-one solar charge inverter for heat dissipation. Do not install the all-in-one solar charge inverter and lead-acid battery in the same cabinet to avoid corrosion by acid gas generated during battery operation.
- Only the battery that meets the requirements of the all-in-one unit can be charged.
- Poorly connected connections and corroded wires may cause great heat which will melt the wire insulation, burn the surrounding materials, and even cause fires. So, make sure the connectors have been tightened, and the wires are secured with ties to avoid looseness of connections caused by shaking of wires during mobile application.
- The system connection wires are selected according to a current density of not more than 5 A/mm².
- Avoid direct sunlight and rainwater infiltration for outdoor installation.
- Even after the power is turned off, there is still high voltage inside the unit. Do not open or touch the internal components, and avoid related operations until the capacitor completely discharges.
- Do not install the all-in-one solar charge inverter in harsh environments such as moist, oily, flammable or explosive, or heavily dusty areas.
- Polarity at the battery input end of this product shall not be reversed, otherwise it may damage the device or cause unpredictable danger.
- The mains input and AC output are high voltage, so please do not touch the wiring terminals.
- When the fan is working, do not touch it to prevent injury.
- Load equipment input power needs to confirm that this all-in-one solar charge inverter is the only input device, and it is forbidden to use in parallel with other input AC power to avoid damage. It is necessary to confirm that the solar charge inverter is the only input device for load equipment, and it is forbidden to use it in parallel with other input AC power to avoid damage.

2.2 Wiring specifications and circuit breaker selection

Wiring and installation must comply with national and local electrical codes.

Recommended PV array wiring specifications and circuit breaker selection: Since the output current of the PV array is affected by the type, connection method and illumination angle of the PV module, the minimum wire diameter of the PV array is calculated according to its short-circuit current; refer to the short-circuit current value in the PV module specification (the short-circuit current is constant when the PV modules are connected in series; the short-circuit current is the sum of the short-circuit currents of all PV modules connected in parallel); the short-circuit current of the PV array shall not exceed the maximum input current.

➤ **Refer to the table below for PV input wire diameter and switch:**

Models	Recommended PV wiring diameter	Maximum PV input current	Recommended circuit breaker type
HYP4850S100-H	6mm ² /10AWG	22A	2P—25A
HYP4850U100-H	6mm ² /10AWG	22A	2P—25A

Note: The voltage in series shall not exceed the maximum PV input open circuit voltage.

➤ **Refer to the table below for recommended AC input wire diameter and switch:**

Models	Recommended AC input wiring diameter	Maximum bypass input current	Recommended circuit breaker type
HYP4850S100-H	10mm ² /7AWG	40A	2P—40A
HYP4850U100-H	10mm ² /7AWG	63A	2P—63A

Note: There is already an appropriate circuit breaker at the Mains input wiring terminal, so it is not necessary to add one more.

➤ **Recommended battery input wire diameter and switch selection**

Models	Recommended battery wiring diameter	Rated battery discharge	Maximum charge current	Recommended circuit breaker type
HYP4850S100-H	30mm ² /2AWG	125A	100A	2P—160A
HYP4850U100-H	30mm ² /7AWG	125A	100A	2P—200A

➤ **Recommended AC output wiring specifications and circuit breaker selection**

Models	Recommended AC output wiring	Rated inverter AC output current	Maximum bypass output current	Recommended circuit breaker type
HYP4850S100-H	10mm ² /7AW	22A	40A	2P—40A
HYP4850U100-H	10mm ² /7AWG	42A	63A	2P—63A

Note: The wiring diameter is for reference only. If the distance between the PV array and the all-in-one solar charge inverter or the distance between the all-in-one solar charge inverter and the battery is relatively long, using a thicker wire can reduce the voltage drop to improve system performance.

Note: The above are only recommended wiring diameter and circuit breaker. Please select the appropriate wiring diameter and circuit breaker according to actual situations.

2.3 Installation and wiring

Installation steps::

Step 1: Determine the installation position and the space for heat dissipation. Determine the installation position of the all-in-one solar charge inverter, such as wall surface; when installing the all-in-one solar charge inverter, ensure that there is enough air flowing through the heat sink, and space of at least 200mm to the left and right air outlets of the inverter shall be left to ensure natural convection heat dissipation. Refer to the installation diagram of the whole machine as above.



Warning: Danger of explosion! Never install the all-in-one solar charge inverter and lead-acid battery in the same confined space! Also do not install in a confined place where battery gas may collect.

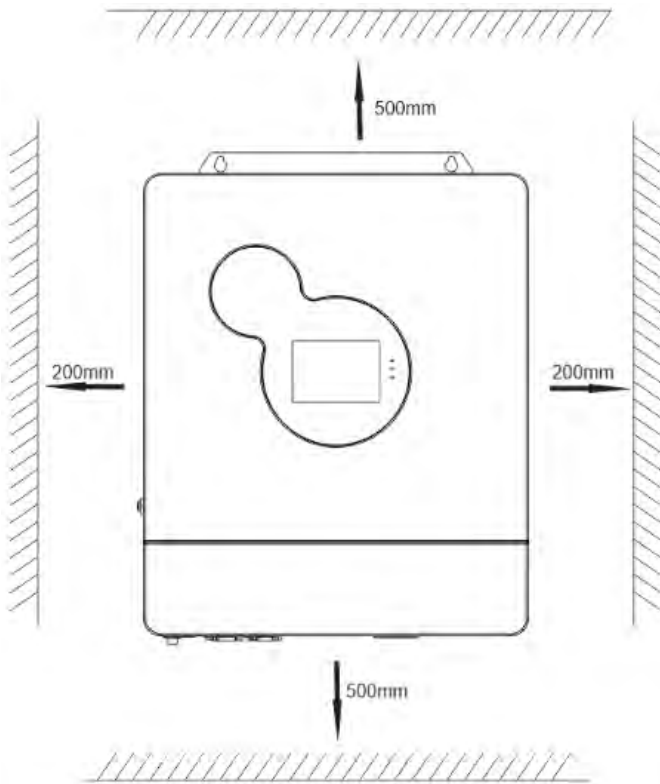

Step 2: Remove the terminal cover

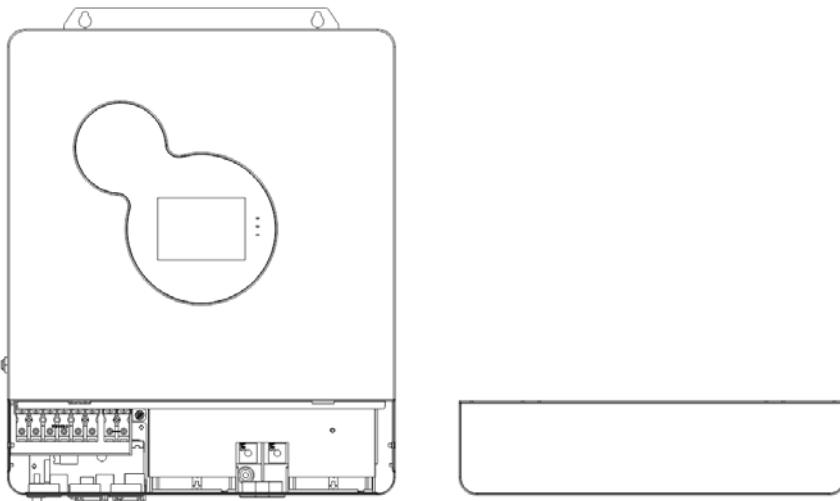

Step3: Wiring

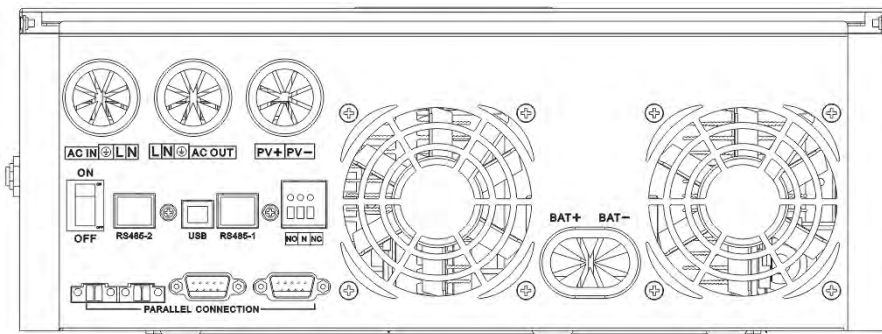

AC input / output wiring method:

- ① Prior to AC input/output wiring, opening the external circuit breaker and confirm that the wire used is thick enough. Please refer to Section 2.2 “Wiring Specifications and Circuit Breaker Selection” ;
- ② Properly connect the AC input wire according to the wire sequence and terminal position shown in the figure below. Please connect the ground wire first, and then the live wire and the neutral wire;



: Ground

L: Live

N: Neutral

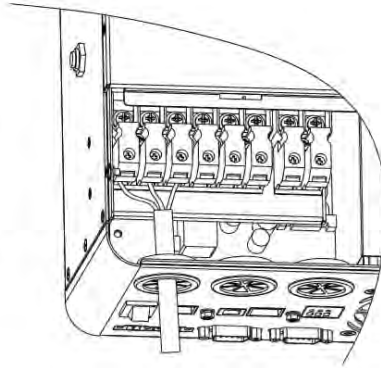
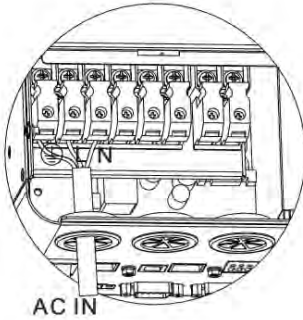

- ③ Properly connect the AC output wire according to the wire sequence and terminal position shown in the figure below. Please connect the ground wire first, and then the live wire and the neutral wire. The ground wire is connected to the grounding screw hole on the cabinet through the O-type terminal.



: Ground

L: Live

N: Neutral

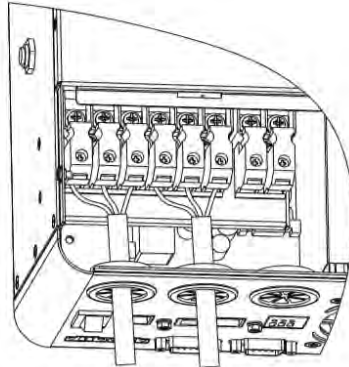
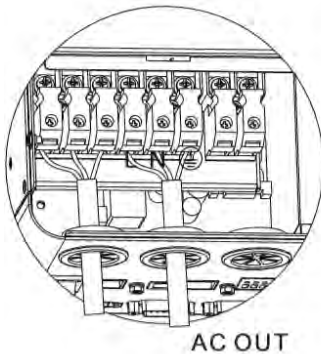

Note: The grounding wire shall be as thick as possible (cross-sectional area is not less than 4mm²). The grounding point shall be as close as possible to the all-in-one solar charge inverter. The shorter the grounding wire, the better.

PV input wiring method:

- ① Prior to wiring, disconnect the external circuit breaker and confirm that the wire used is thick enough. Please refer to Section 2.2 “Wiring Specifications and Circuit Breaker Selection” ;
- ② Properly connect the PV input wire according to the wire sequence and terminal position shown in the figure below: When used in parallel connection, different machines need to be connected to different PV arrays or PV sources.

PV+: PV input positive pole

PV-: PV input negative pole

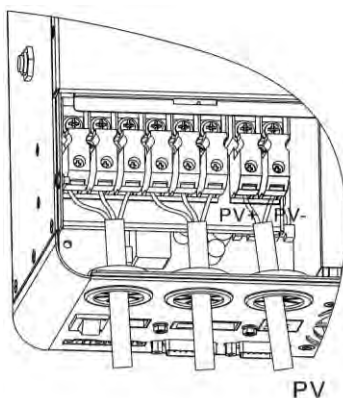

BAT wiring method:

- ① Prior to wiring, disconnect the external circuit breaker and confirm that the wire used is thick enough. Please refer to Section 2.2 “Wiring Specifications and Circuit Breaker Selection” . The BAT wire needs to be connected to the machine through the O-type terminal. The O-type terminal with an inner diameter of 6mm is recommended. The O-type terminal shall firmly press the BAT wire to prevent excessive heat generation caused by excessive contact resistance;
- ② Properly connect the BAT wire according to the wire sequence and terminal position shown in the figure below.

BAT+: Battery positive electrode

BAT-: Battery negative electrode

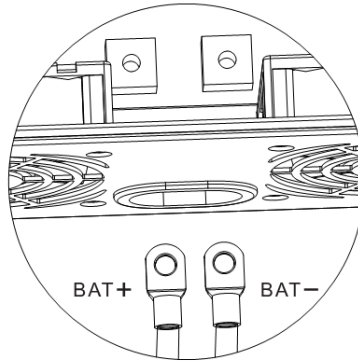

Warnings:

- ① Mains input, AC output and PV array will generate high voltage. So, before wiring, be sure to opening the circuit breaker or fuse;
- ② Be very careful during wiring; do not close the circuit breaker or fuse during wiring, and ensure that the “+” and “-” pole leads of each component are connected properly; a circuit breaker must be installed at the battery terminal. Refer to Section 2.2 “Wiring Specifications and Circuit Breaker Selection” to select a right circuit breaker. Before wiring, be sure to disconnect the circuit breaker to prevent strong electric sparks and avoid battery short circuit; if the all-in-one solar charge inverter is used in an area with frequent lightning, it is recommended to install an external lightning arrester at the PV input terminal.

Step 4: Check if the wiring is correct and firm. In particular, check if the battery polarity is reversed, if the PV input polarity is reversed and if the AC input is properly connected.

Step 5: Install the terminals cover.

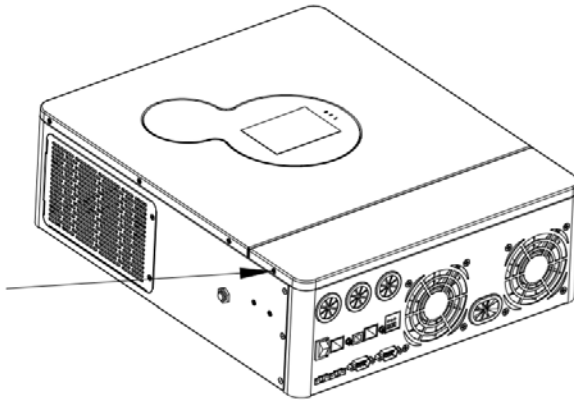

Step 6: Turn on the all-in-one solar charge inverter

First, close the circuit breaker at the battery terminal, and then turn the rocker switch on the left side of the machine to the "ON" state. The "AC/INV" indicator flashing indicates that the inverter is working normally. Close the circuit breakers of the PV array and the Mains. Finally, turn on AC loads one by one as the AC output is normal to avoid a protection action caused by a large momentary shock due to simultaneous turning on the loads simultaneously. Now, the machine goes into a normal operation according to the set mode.

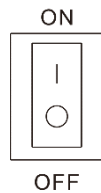

Note: If power is supplied to different AC loads, it is recommended to first turn on the load with a large surge current. After the load is stable, turn on the load with a small surge current.

Note: If the all-in-one solar charge inverter does not work properly or the **LCD** or indicator is abnormal, refer to Chapter 6 to handle the exceptions.

2.4 Parallel machine wire connection

2.4.1 Introduction

1. Up to six units connected in parallel.
2. When using the parallel operation function, the following connecting lines (package accessories) shall be firmly and reliably connected:

DB15 Parallel communication line*1:



Current sharing detection line*1:

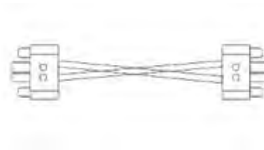

2.4.2 Precautions for connecting the parallel connecting lines

Warning: 

1. PV connection:

When used in parallel connection, different machines need to be connected to different PV arrays or PV sources.

2. Battery wiring:

Parallel connection in single or split phase: Ensure that all all-in-one solar charger inverters are connected to the same battery, with BAT + connected to BAT + , BAT - connected to BAT -, and that the connection is correct with the same wiring length and line diameter before power on and start-up, so as to avoid the abnormal operation of parallel system output caused by wrong connection.

3. AC OUT wiring:

Parallel connection in single phase: Ensure L-to-L, N-to-N and PE-to-PE connection for all all-in-one solar charger inverters, and that the connection is correct with the same wiring length and line diameter before power on and start-up, so as to avoid the abnormal operation of parallel system output caused by wrong connection. For specific wiring, please refer to 2.4.3 Wiring Diagram

Parallel connection in split phase: Ensure N-to-N and PE-to-PE connection for all all-in-one

solar charger inverters. The **L** lines of all inverters connected to the same phase need to be connected together. But **L** lines of different phases cannot be joined together. Other connection precautions are the same as parallel connection in single phase. For specific wiring, please refer to 2.4.4 Wiring Diagram

4. **AC IN wiring:**

Parallel connection in single phase: Ensure L-to-L, N-to-N and PE-to-PE connection for all all-in-one solar charger inverters, and that the connection is correct with the same wiring length and line diameter before power on and start-up, so as to avoid the abnormal operation of parallel system output caused by wrong connection. Meanwhile, it is not allowed to have multiple different AC source inputs to avoid damage to the external equipment of the inverter. The consistency and uniqueness of AC source input shall be ensured. For specific wiring, please refer to 2.4.3 Wiring Diagram.

Parallel connection in split phase: Ensure N-to-N and PE-to-PE connection for all all-in-one solar charger inverters. The **L** lines of all inverters connected to the same phase need to be connected together. But **L** lines of different phases cannot be joined together. Other connection precautions are the same as parallel connection in single phase. For specific wiring, please refer to 2.4.4 Wiring Diagram.

5. **Wiring of parallel communication line:**

Parallel connection in single or split phase: Our company's parallel communication line is a DB15 standard computer cable with shielding function. Ensure the "one-in-one-out" rule when connecting each inverter, that is, connect the male connector (out) of this inverter with the female connector (in) of the inverter to be paralleled. Do not connect the male connector of the inverter to its female connector. In addition, make sure to tighten the parallel communication line of each inverter with self-contained end screws of DB15 to avoid the abnormal operation or damage of the system output caused by the falling off or poor contact of the parallel communication line.

6. **Wiring of current sharing detection line:**

Parallel connection in single phase: Our company's current sharing detection line is a twisted connection line. Ensure the "one-in-one-out" rule when connecting each inverter, that is, connect the current sharing line of the inverter with the current sharing green port of the inverter to be paralleled (choose one port from the two, and there is no mandatory sequence

requirement). The current sharing ports of the inverter cannot be connected to each other. In addition, make sure that the red and black current sharing connection lines of each inverter are not manually exchanged, and make sure to tighten the lines with self-contained screws to avoid the abnormal operation or damage of the system output caused by abnormal parallel current sharing detection. For specific wiring, please refer to 2.4.3 Wiring Diagram.

Parallel connection in split phase: The current sharing detection lines of all inverters connected to the same phase need to be connected together. But the current sharing detection lines of different phases cannot be joined together. Other connection precautions are the same as parallel connection in single phase. For specific wiring, please refer to 2.4.4 Wiring Diagram.

7. Before or after connecting the system, please carefully refer to the following system wiring diagram to ensure that all wiring is correct and reliable before power on.
8. After the system is wired, powered on and in normal operation, if a new inverter needs to be connected, make sure to disconnect the battery input, PV input, AC input and AC output, and that all all-in-one solar charger inverters are powered off before reconnecting into the system.

2.4.3 Schematic diagram of parallel connection in single phase

1. The parallel communication line and current sharing detection line of the all-in-one solar charger inverter need to be locked with screws after connecting. The schematic diagram is as follows:

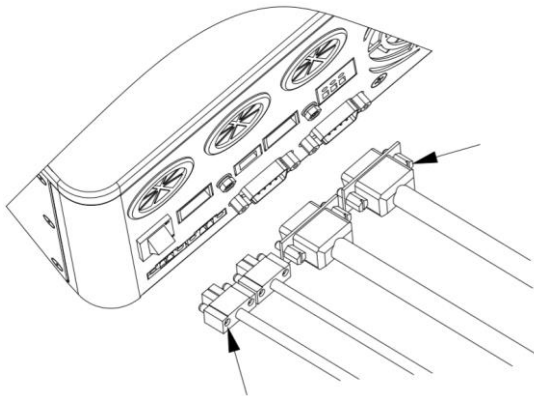

2. In case of parallel operation with multiple inverters, the schematic diagram of parallel connection is as follows:
 - a) **Two all-in-one solar charger inverters of the system connected in parallel:**

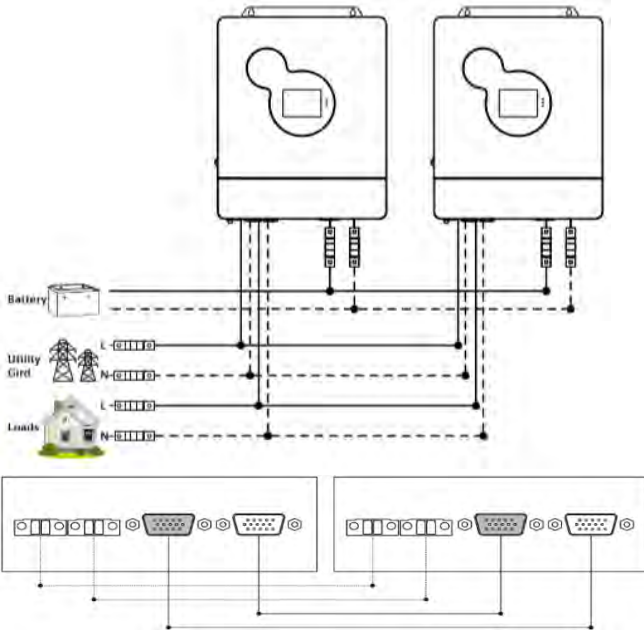

b) Three all-in-one solar charge inverters of the system connected in parallel:

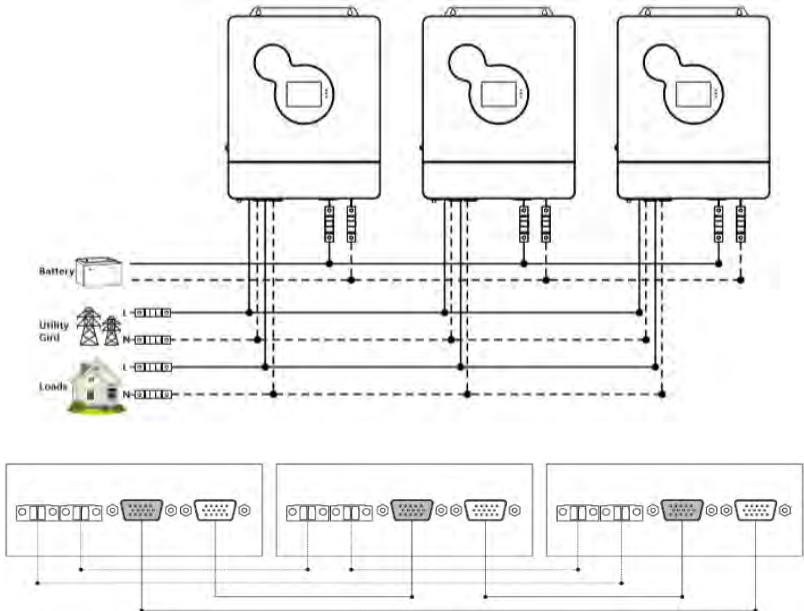

c) Four all-in-one solar charge inverters of the system connected in parallel:

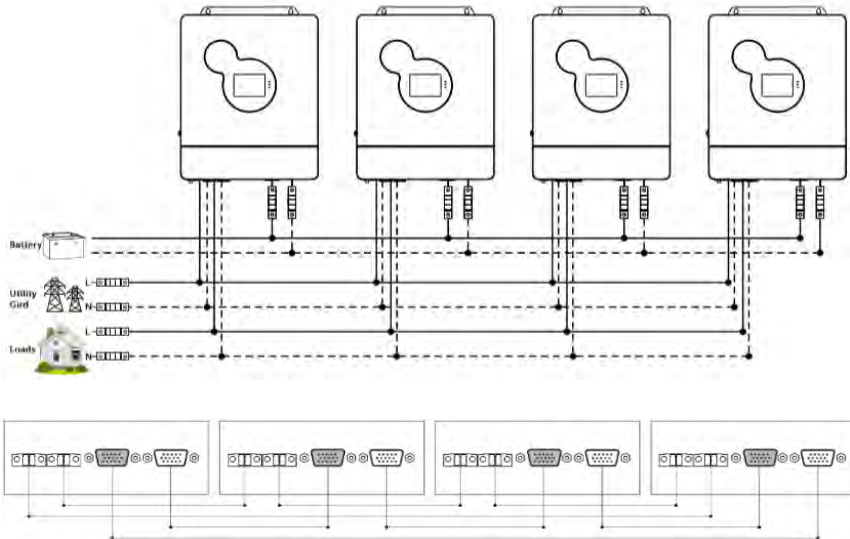

d) Five all-in-one solar charge inverters of the system connected in parallel:

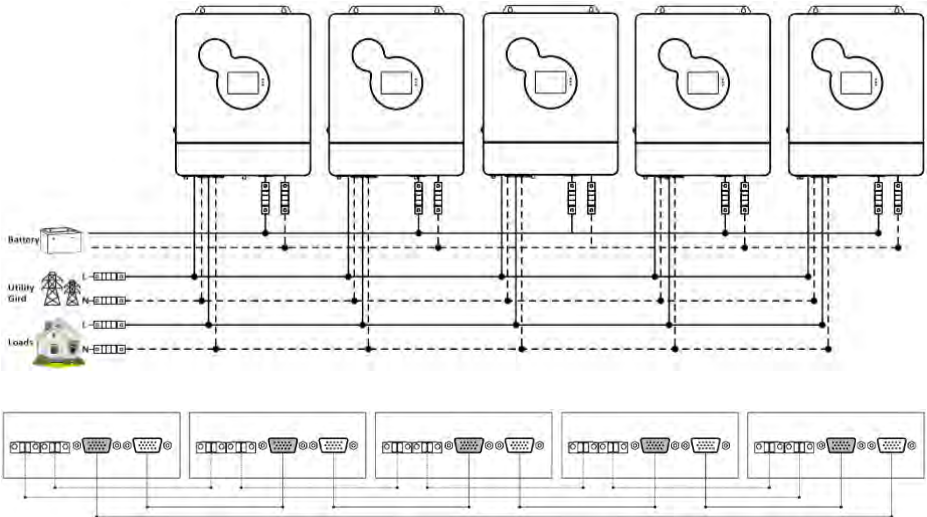

e) **Six all-in-one solar charger inverters of the system connected in parallel:**

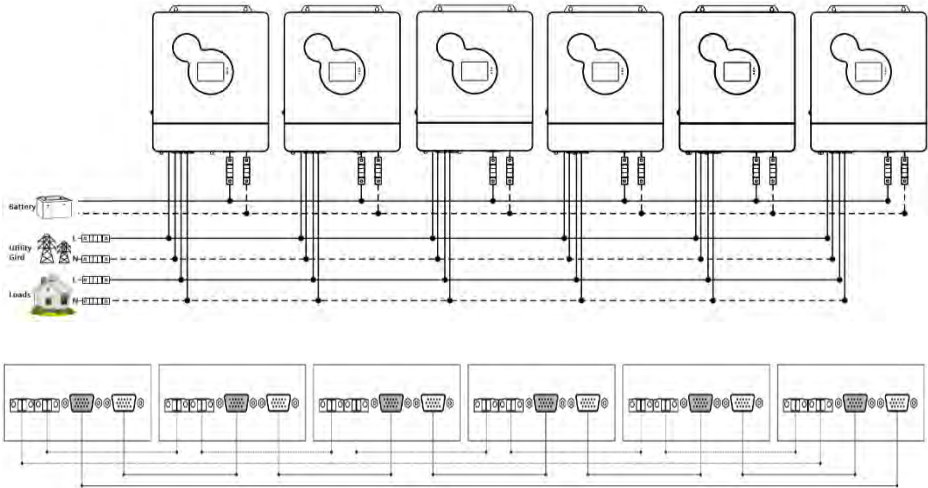

2.4.4 Schematic diagram of parallel connection in split phase

1. The parallel communication line and current sharing detection line of the all-in-one solar charger inverter need to be locked with screws after connecting. The schematic diagram is as follows:

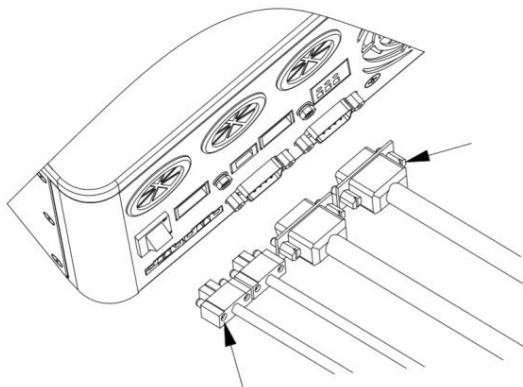

2. In case of parallel operation with multiple inverters, the schematic diagram of parallel connection is as follows:

Parallel Operation in two phase (only for U series model can be set):

- a) **Two all-in-one solar charger inverters of the system connected in two phase:
1+1 system:**

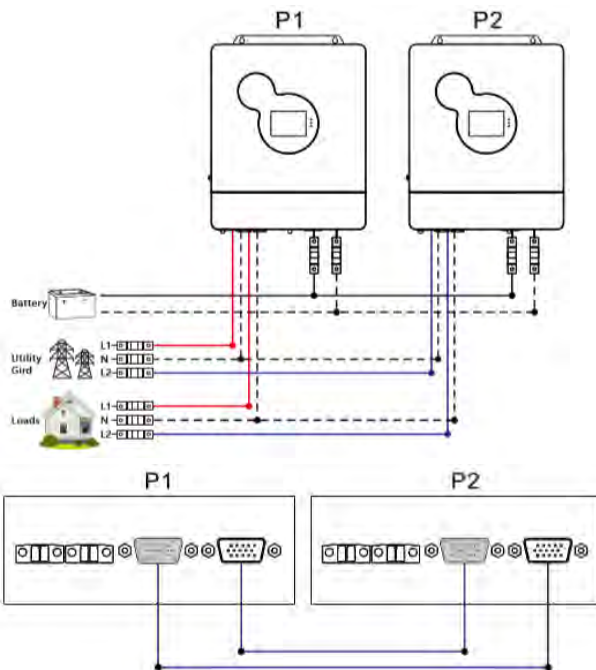

b) Three all-in-one solar charger inverters of the system connected in two phase: 2+1 system:

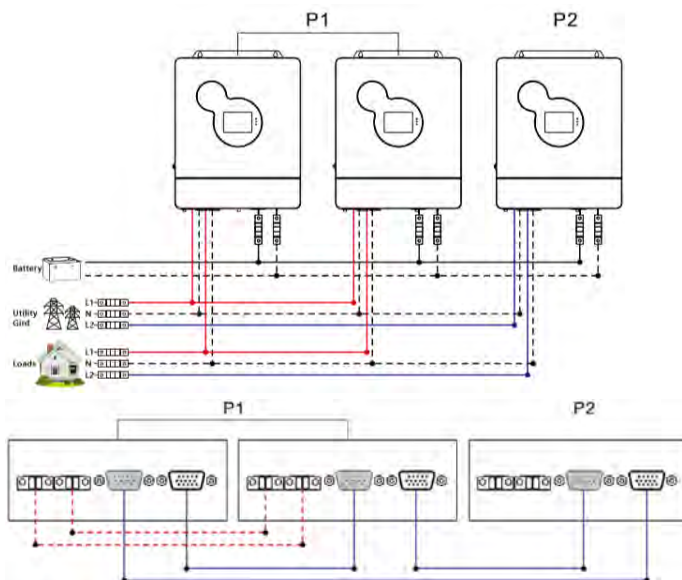

- c) Four all-in-one solar charge inverters of the system connected in two phase:
2+2 system:

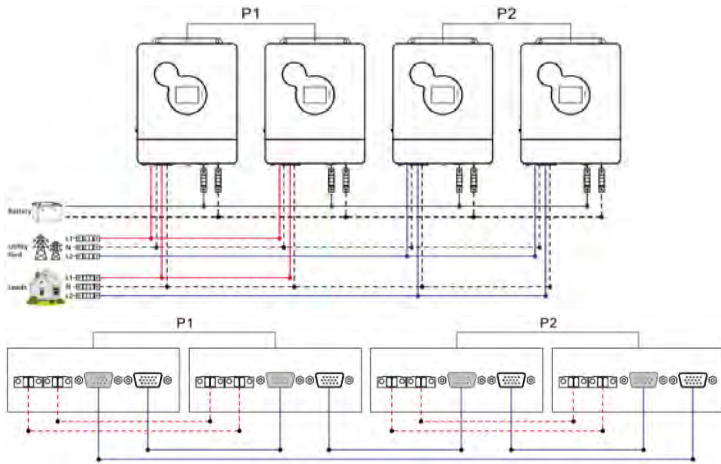

- 3+1 system:

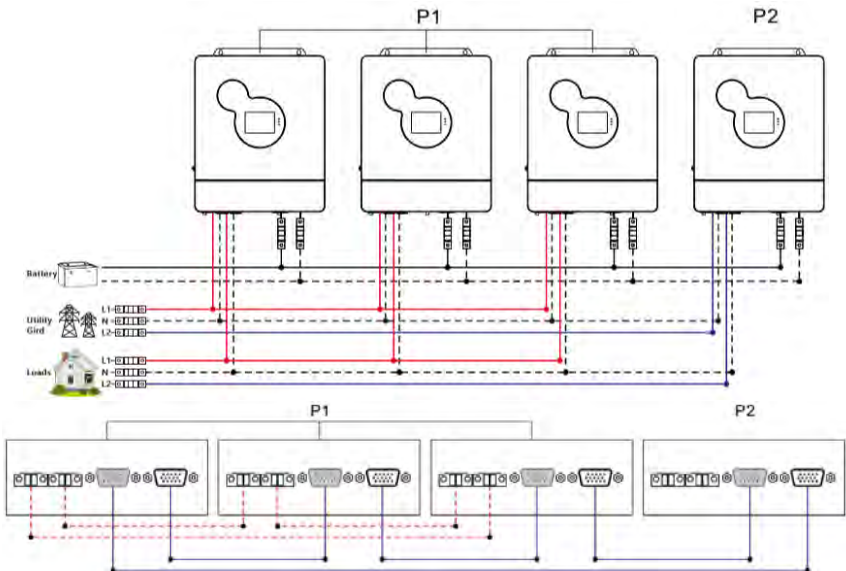

- d) Five all-in-one solar charge inverters of the system connected in two phase:
4+1 system:

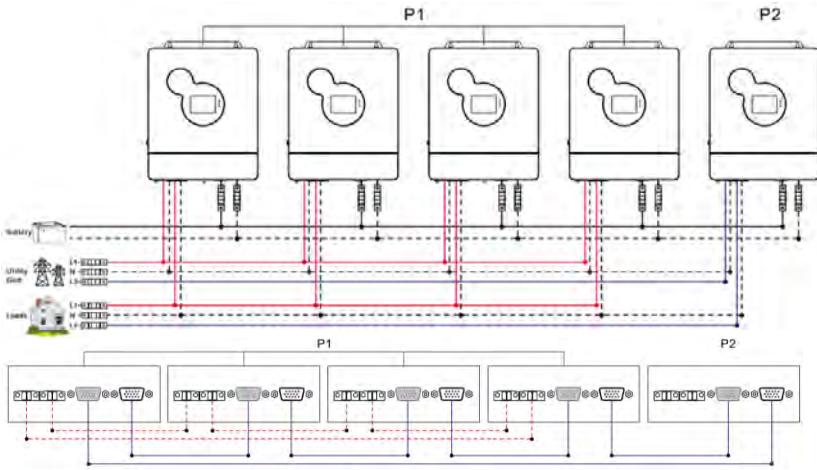

3+2 system:

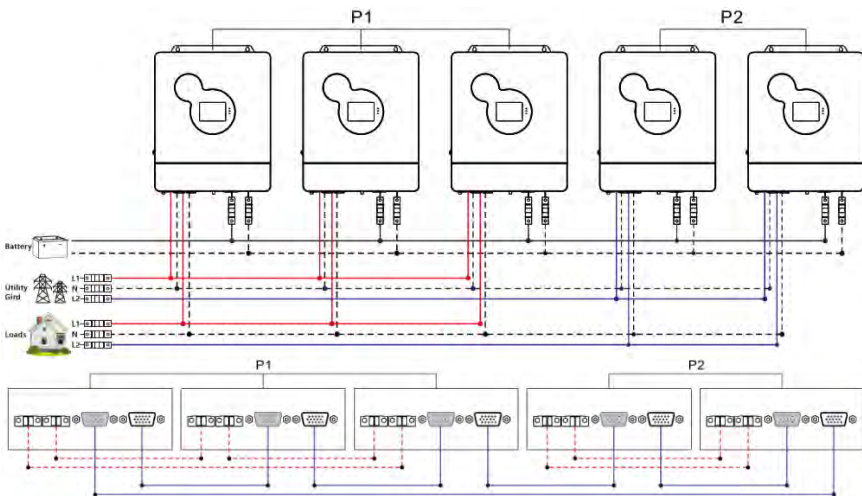

e) Six all-in-one solar charge inverters of the system connected in two phase:

5+1 system:

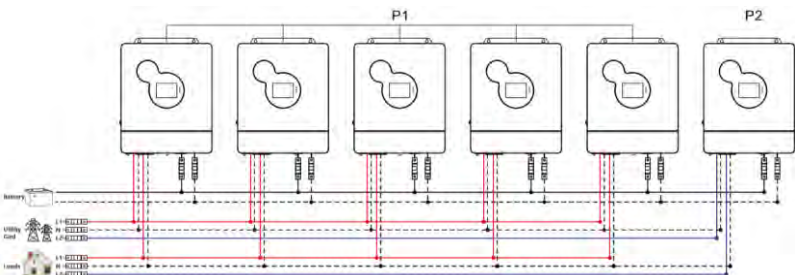

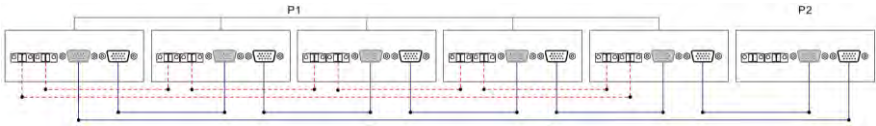

4+2 system:

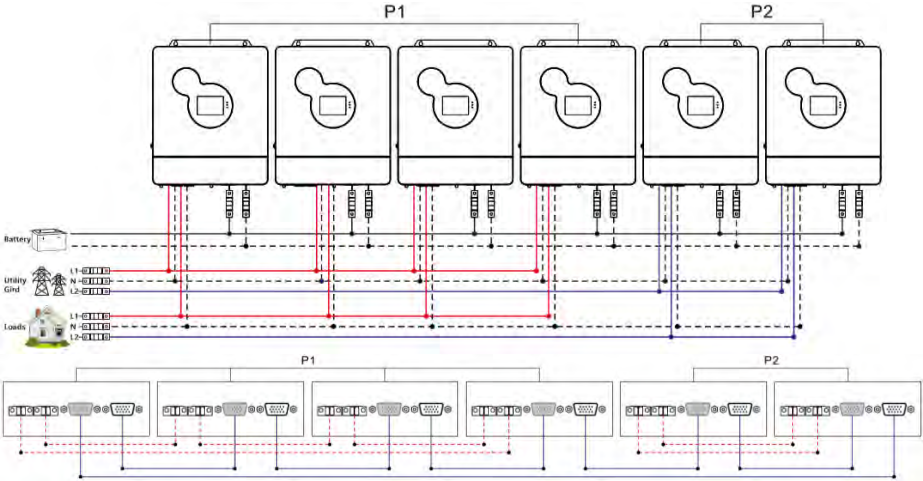

3+3 system:

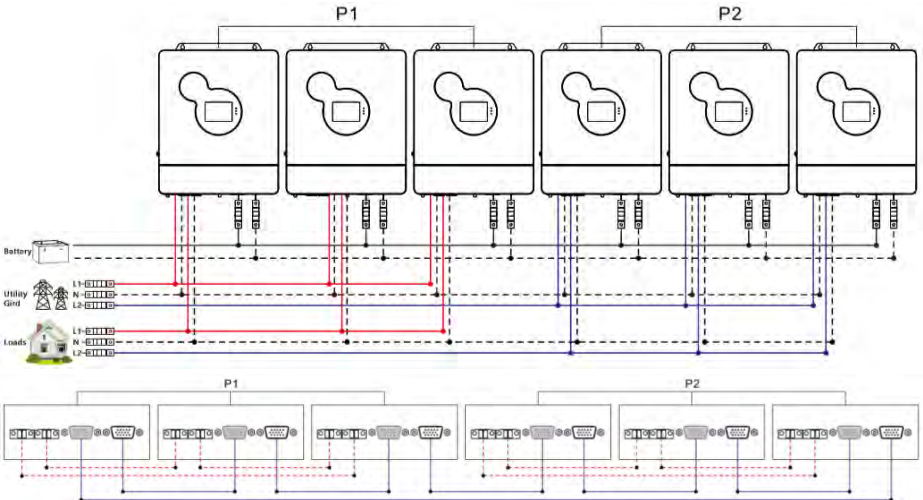

2.4.5 Schematic diagram of parallel connection in three phase

1. The parallel communication line and current sharing detection line of the all-in-one solar charger inverter need to be locked with screws after connecting. The schematic diagram is as follows:

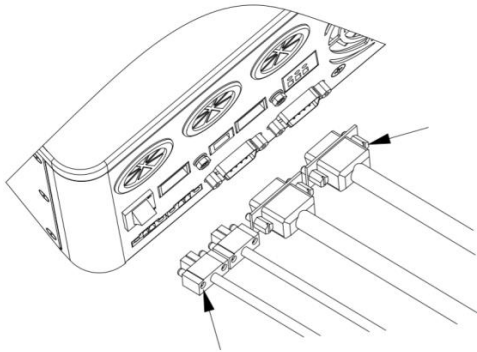

2. In case of parallel operation with multiple inverters, the schematic diagram of parallel connection is as follows:

Parallel Operation in three phase :

a) **Three all-in-one solar charge inverters of the system connected in three phase:**

1+1+1 system:

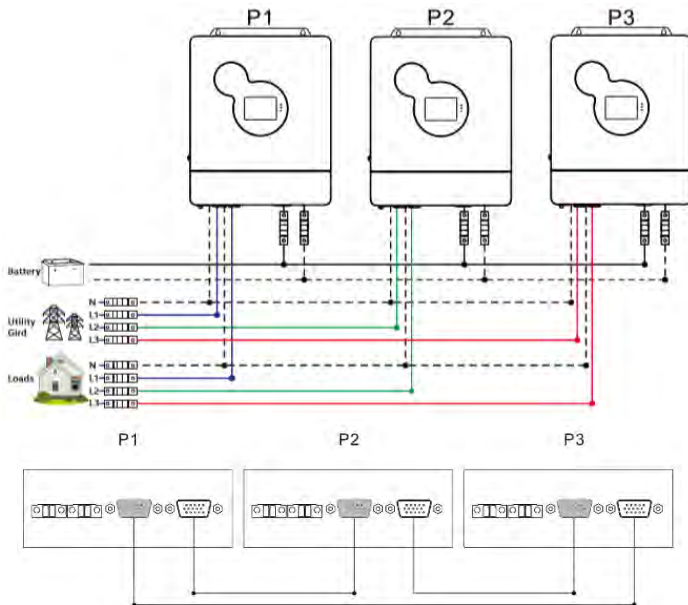

b) **Four all-in-one solar charge inverters of the system connected in three phase:**

2+1+1 system:

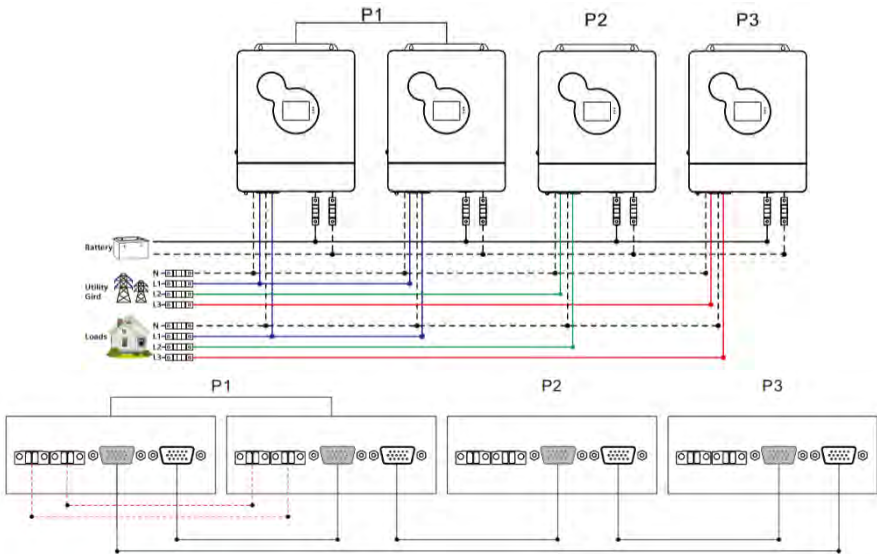

c) **Five all-in-one solar charge inverters of the system connected in three phase: 3+1+1 system:**

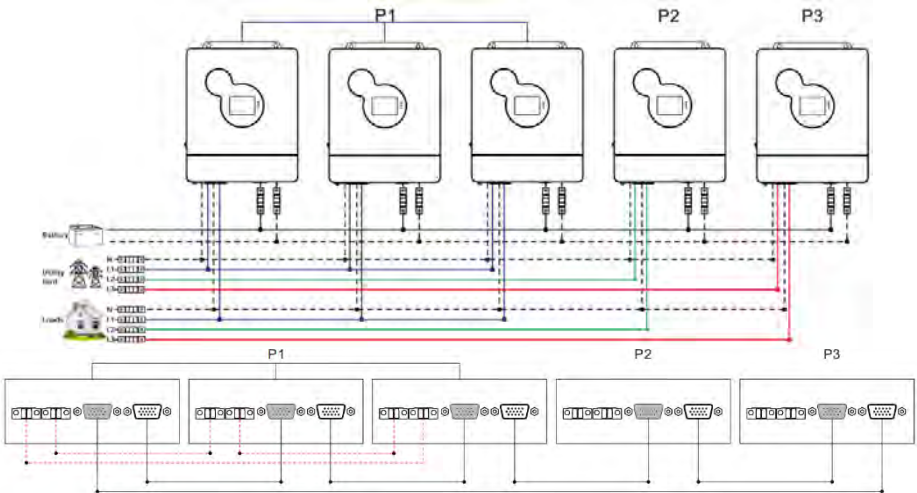

2+2+1 system:

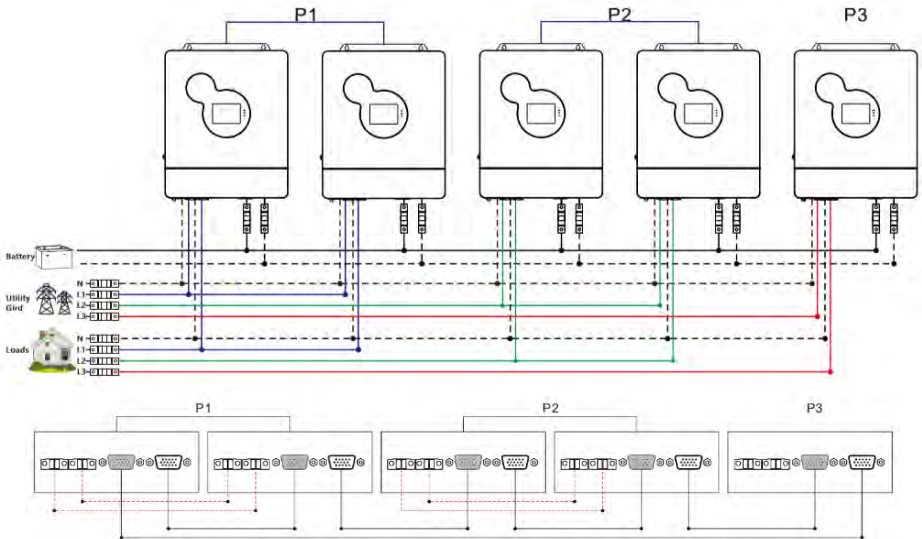

d) Six all-in-one solar charge inverters of the system connected in three phase:

2+2+2 system:

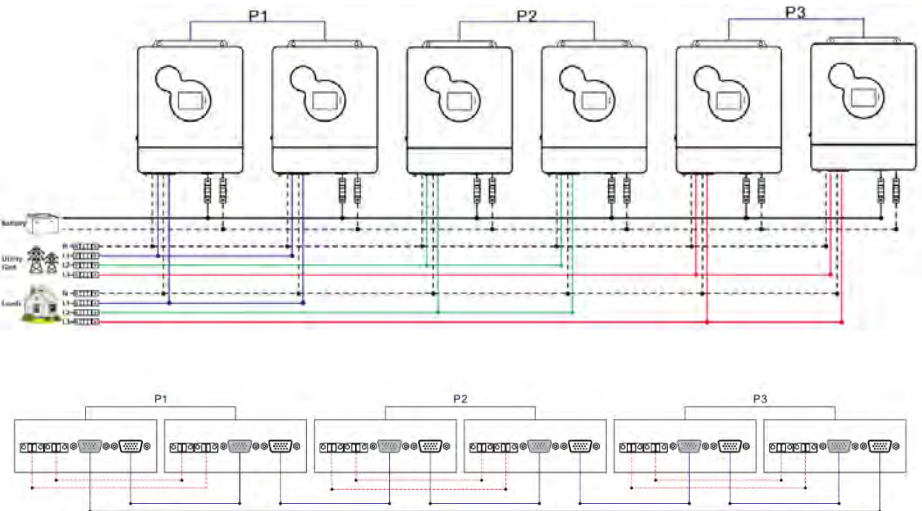

3+2+1 system:

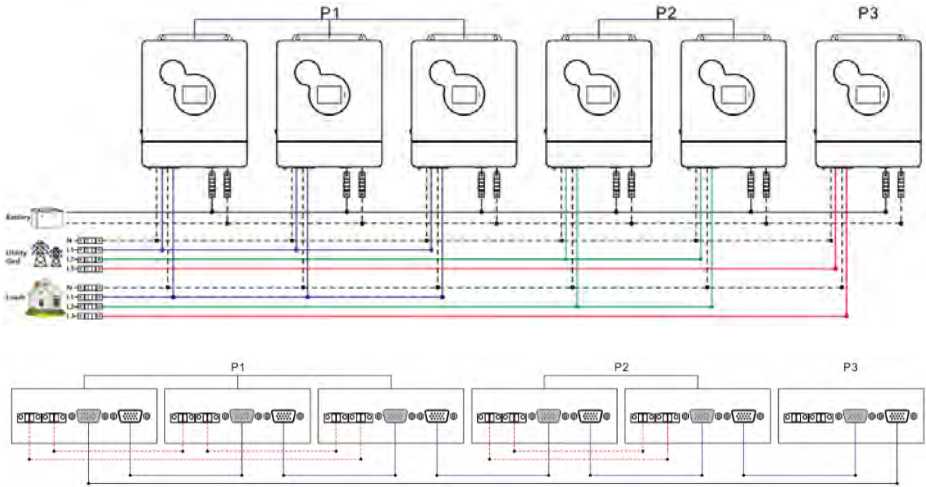

4+1+1 system:

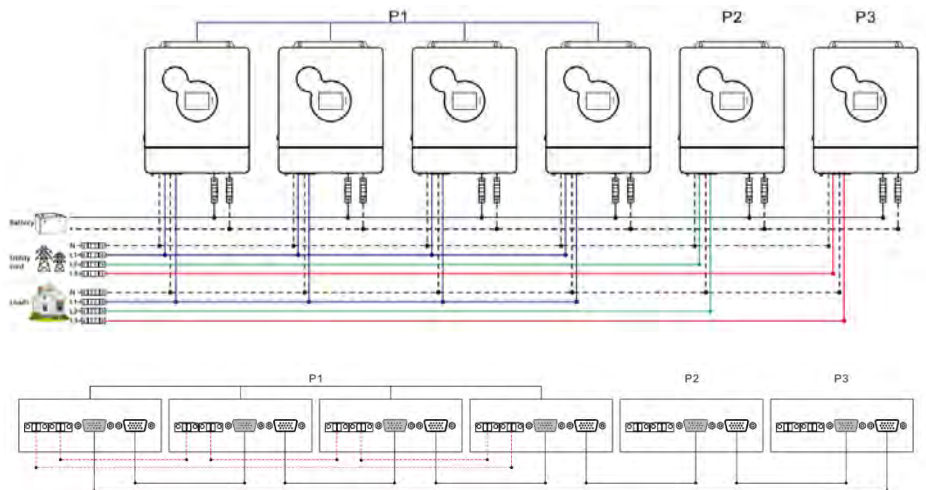

Note:

- 1) Before starting up and running, please check whether the connection was correct to avoid any abnormalities in the system.
- 2) All wiring must be fixed and reliable to avoid wire drop during use.
- 3) When the AC output is wired to the load, it shall be properly wired according to the requirements of the electrical load equipment to avoid damage to the load equipment.
- 4) Settings **[38]** need to be set consistently or only for the host. When the machine is running, the voltage set by the host shall prevail, and the master will force the rewrite of the other slave machines to keep the same set. Only can be set in the standby mode.
- 5) Machine factory default for single machine mode, if you use parallel, split-phase or three-phase function, you need to set the [31] item parameters through the screen. The setting method is: power on one machine at a time, the rest of the machine off, and then set the [31] item parameters according to the site system operation mode. After this machine is set successfully, turn off the machine switch and wait for the machine to be powered down, then set the rest of the machines in turn until all machines are set, and then all machines are powered up again at the same time and enter the working state.

The **[31]** setting item:

When in single phase parallel connection : setting **[31]** should be set as **[PAL]**

When in single phase parallel connection, setting **[31]** should be set as follows:

When in three phase parallel connection ,all machines in phase 1 must be set as **[3P1]** , all machines in phase 2 must be set as **[3P2]** all machines in phase 3 must be set as **[3P3]** , at present, the voltage phase difference between P1-P2, P1-P3 and P2-P3 is 120 degrees.

- a. When the output voltage set in the setting **[38]** is 120 Vac (U model), the line voltage between L1 in phase 1 and L2 in phase 2 is $120 \times 1.732 = 208$ Vac, similarly the line voltage between L1-L3, L2-L3 is 208 Vac; the single phase voltage between L1-N, L2-N, L3-N is 120 Vac.
- b. When the output voltage set in the setting **[38]** is 230Vac (S model), the line voltage between the live wire L1 in phase 1 and the live wire L2 in phase 2 is $230 \times 1.732 = 398$ Vac, and similarly the line voltage between L1-L3, L2-L3 is 398Vac; the single phase voltage between L1-N, L2-N, L3-N is 230Vac.

In split phase parallel connection (U), All connected P1-phase inverters are set to "2P0":

1) If all connected P2-phase inverters are set to "2P1", AC output line voltage difference is 120 degrees (L1-L2), line voltage is $120 \times 1.732 = 208$ Vac; Phase voltage is 120Vac (L1-N; L2-N).

2) If all connected P2-phase inverters are set to "2P2", AC output line voltage difference is 180 degrees (L1-L2), line voltage is $120 \times 2 = 240$ Vac; Phase voltage is 120Vac (L1-N; L2-N).

- 6) After the system runs, the output voltage is measured correctly, and then the load setting is connected.

3. Operating modes

3.1 Charging mode

1. **Solar First:** priority shall be given to charging by PV, and mains charging will be started only when the PV has failed. It can fully utilize solar energy to generate power in the daytime and then switch to mains charging to keep the battery level, and can be used in regions where the grid is relatively stable and the feed-in tariff is relatively expensive.

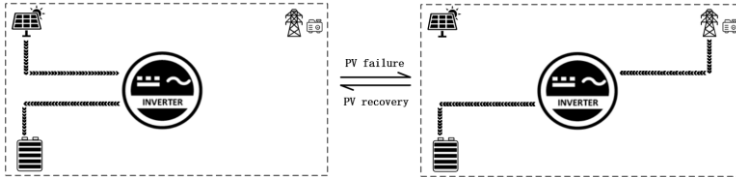

2. **Mains First:** priority shall be given to charging by Mains Power, and charging with PV power will be started only when the Mains has failed.

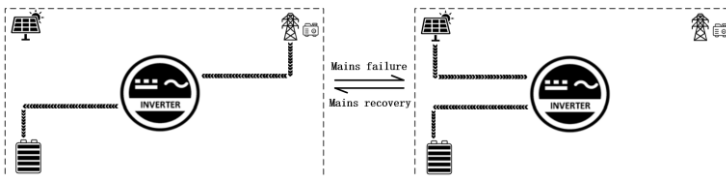

3. **Hybrid Charging:** hybrid charging of PV and Mains Power, give priority to PV MPPT charging, and supplement Mains Power when PV energy is insufficient. When the PV energy is sufficient, the Mains Power will stop charging. This is the mode of fast charging and suitable for unstable areas of power grid, and can provide sufficient backup power at any time.

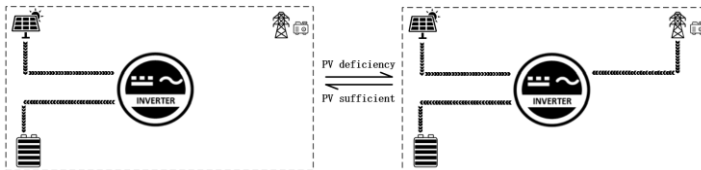

4. **Only Solar:** Only PV charging, no mains charging is initiated. This is the most energy-efficient mode and the battery power comes from solar energy, which is usually used in regions with good daylighting conditions.

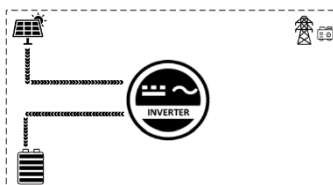

3.2 Output mode

1. **Solar First:** PV and battery will power the load, with diversified charging modes available and output mode optional, when the Solar First Mode is selected, the use of green solar energy can be maximized for energy efficiency and emission reduction. Switch to Mains Power when PV has failed. This mode can maximize the use of solar energy while maintaining the battery power, which is suitable for regions with relatively stable power grid.

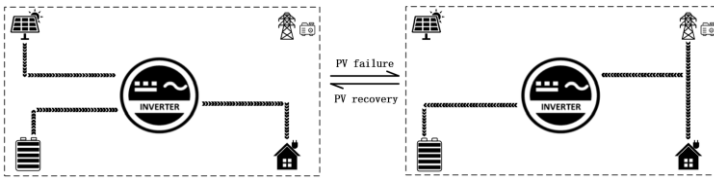

2. **Mains First:** switch to inverter power supply only when Mains Power has failed, which is equivalent to backup UPS and is used in regions with unstable power grid.

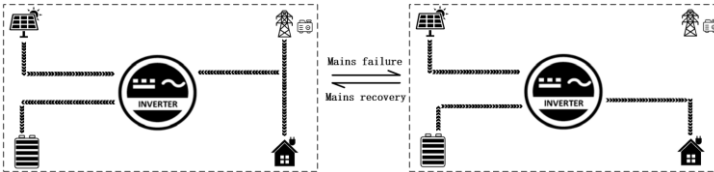

3. **Inverter First:** switch to Mains Power supply only when the battery is under-voltage. This mode uses DC energy to the maximum extent and is used in regions with stable power grid.

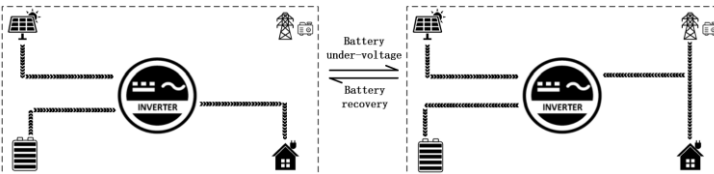

4. **Hybrid output and grid connection (need to be able)** In the utility bypass state, when no battery is connected or when the battery is full, the load power is supplied by the PV and the utility together if the hybrid function is enabled, and the surplus PV energy is fed back to the grid if the grid connection function is enabled.





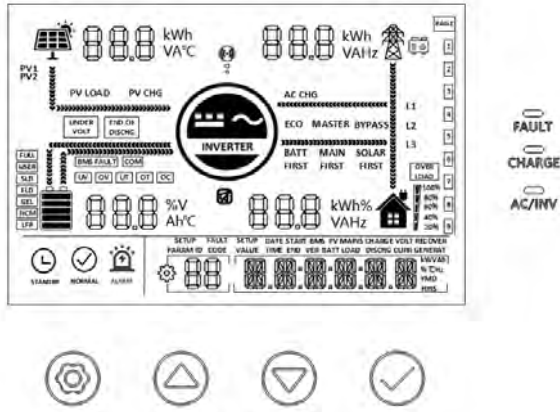

4. LCD screen operating instructions

4.1 Operation and display panel

The operation and display panel is shown below, including one LCD screen, 3 indicator lights and 4 operation buttons.



Operation buttons introduction

Function Key	Description
	Menu of Enter/Exit Settings
	Page Number/Option Increase
	Page Number/Option Decrease
	Under the menu of Settings, OK/Enter Options







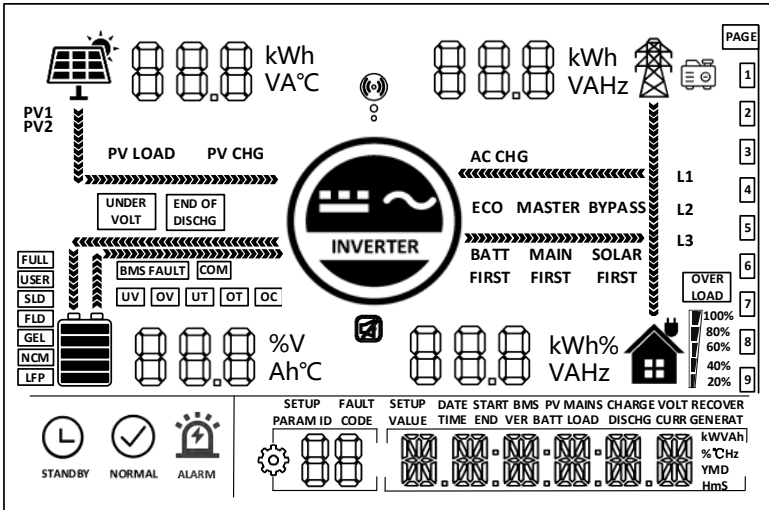

Indicators introduction

Indicator light	Color	Description
AC/INV	Yellow	Normally On: Mains Power output
		Flicker: Inverter output
CHARGE	Green	Flicker: The battery is being charged.
		Normally On: The charging is completed.
FAULT	Red	Normally On: Fault status

LCD screen introduction



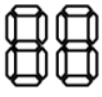
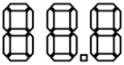
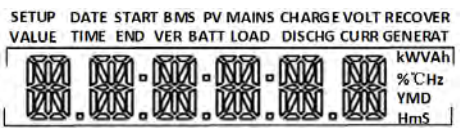

Icon	function	Icon	function
	Indicates mains power		Indicates the inverter is working
	Indicates generator		Indicates home appliances
	Indicates solar power		Indicates AC output is overload
	<ul style="list-style-type: none"> Battery remaining capacity is below 5% Battery remaining capacity is 5%~19% Battery remaining capacity is 20%~39% Battery remaining capacity is 40%~59% Battery remaining capacity is 		<ul style="list-style-type: none"> Load percentage is below 5% Load percentage is 5%~19% Load percentage is 20%~39% Load percentage is 40%~59% Load percentage is 60%~79%

	60%~79%  Battery remaining capacity is 80%~100%		 Load percentage is 80%~100%
	Indicates that the machine is communicating with the Surveillance Equipment		Indicates that the buzzer is not enabled
FULL	Indicates that the battery is fully charged	USER	Indicates that the current battery type of the machine is user-defined
SLD	Indicates that the current battery type of the machine is sealed lead-acid battery	FLD	Indicates that the current battery type of the machine is flooded lead-acid battery
GEL	Indicates that the current battery type of the machine is gel battery	NCM	Indicates that the current battery type of the machine is NCM battery
LFP	Indicates that the current battery type of the machine is LFP battery	PAGE	Display the page number prompt of the main interface
1 2 3 4 5 6 7 8 9			Indicates the data page of the main display interface
 STANDBY	Indicates that the machine is currently idle	 NORMAL	Indicates that the machine is currently in normal operation
 ALARM	Indicates that the machine is currently in an alarm or fault state		Indicates that the machine is currently in the parameter setting state
PV LOAD	Indicates that the PV is in a direct load state	PV CHG	Indicates that the PV is in a state of charge
AC CHG	Indicates that the AC is in a state of charge	BYPASS	Indicate that the Mains Power is in the bypass state
ECO	Indicates that the system is enabled in the ECO mode	BATT FIRST	Indicates that the output mode is Battery First







MAIN FIRST	Indicates that the output mode is Mains Power first	SOLAR FIRST	The indicated output mode is Solar First.
UNDER VOLT	Indicates battery under voltage	END OF DISCHG	Indicates battery overvoltage
COM	Indicates internal communication failure	UV	Indicates system under voltage
OV	Indicates system over voltage	UT	Indicates system low temperature
OT	Indicates system over temperature	OC	Indicates system over current
BMS FAULT	Indicates BMS communication failure		Indicates the direction of energy flow
	When the system is in alarm or fault state, the main interface displays fault code; display setting options when setting		Display parameters of PV, battery, mains power and load
		Main Interface: display real-time time, date, total PV power generation, total load power consumption, RS485 address, version number Setting Interface: display setting contents	

Real-time data viewing method

On the LCD main screen, press   the button for page turning to view the real-time data of the machine.

Page	PV side parameters	Battery side parameters	Mains side parameters	Load side parameters	Comprehensive parameters
1	PV Voltage	Battery Voltage	AC Voltage	Load Voltage	Current Time
2	PV Current	Battery Current	AC Current	Load Current	Current Date
3	PV Power	BMS Batt SOC	AC Power	Load Power	PV Total kWh
4	PV Today kWh	BMS Batt Voltage	Reserved	Load Today kWh	Load Total kWh
5	PV Temperature	INV Temperature	AC Frequency	Load Frequency	RS485 Address
6	Maintenance Parm	Battery Rated Voltage	Reserved	Load kVA	Soft Version
7	PV Rated Voltage	Battery Rated Current	Reserved	Load Rated Power	Parallel Mode

4.2 Setup parameters description

Key Operation Instructions: Enter the setting menu and exit the setting menu, please press  , After entering the setting menu, the parameter number [00] will flash. At this time, you can press the  and  key to select the parameter code to be set. Then press  to enter the parameter editing state, at this time, the value of the parameter flashes, adjust the value of the parameter through the  and  , and finally press  to complete the editing of the parameter and return to the parameter selection state.

Parameter Number	Parameter Name	Setting options	Description
00	Exit	[00]ESC	Menu of Exit Settings
01	Supply Priority Mode	[01] AC1ST Default	Mains Power First Mode, switch to the Inverter only when the Mains Power has failed
		[01] BT1ST	Inverter First Mode: switch to Mains Power only when the battery is under-voltage or lower than Parameter [04] Set Value.

		[01] PV1ST	Solar First Mode: switch to Mains Power when PV has failed or battery is lower than Parameter [04] Set Value.
02	Output Frequency	[02] 50.0 Default	Bypass self-adaptation; when the mains is connected, it automatically adapts to the mains frequency; when the mains is disconnected, the output frequency can be set through this menu. The default output frequency of the 230V machine is 50HZ, and the 120V machine is 60HZ.
		[02] 60.0	
03	AC Input Voltage	[03] UPS Default	The input mains voltage range of 230V machine is 170~280V Mains input voltage range of 120V machine: 90~140V
		[03] APL	The input mains voltage range of 230V machine is 90~280V Mains input voltage range of 120V machine: 90~140V
04	Battery to Mains	[04] 43.6V Default	When the Parameter [01] = BT1ST/PV1ST, the battery voltage is lower than the set value, and the output is switched from inverter to Mains Power, and the set range is 40V~52V.
05	Mains to Battery	[05] 56.8V Default	When the Parameter [01] = BT1ST/PV1ST, the battery voltage is higher than the set value, and the output is switched from mains to inverter, and the set range is 48V~60V.
06	Charging mode	[06] Hybrid Default	Hybrid charging by PV and under utility grid give priority to PV, and use utility grid for supplementary if PV energy is insufficient. When the PV energy is sufficient, the utility grid will stop charging. Note: PV and utility grid are available for charging at the same time only when the bypass output is loaded, and only PV charging can be activated when the inverter is

			working.
		[06] AC1ST	The Mains Power is charged first, and PV charging is started only when the Mains Power has failed
		[06] PV1ST	Priority shall be given to charging by PV and mains charging will be initiated only when the PV has failed.
		[06] ONLYPV	Only PV charging, no mains charging is enabled.
07	Maximum Charging Current	[07] 60A Default	Set Range of 0~100A
08	Battery type	[08] USER	User-defined, all battery parameters can be set.
		[08] SLd	Sealed lead-acid battery with constant charge voltage of 57.6V and floating charge voltage of 55.2V
		[08] FLd	Flooded lead-acid battery with constant charge voltage of 57.6V and floating charge voltage of 55.2V
		[08] GEL Default	GEL lead-acid battery with constant charge voltage of 56.8V and floating charge voltage of 55.2V
		[08]LFP14/LFP15/LFP16	LFP14/LFP15/LFP16 are corresponding to Battery Series of 14, 15 and 16, and their default constant charge voltages are 49.6V, 53.2V and 56.8V respectively, which can be adjusted.
		[08] NCM13/NCM14	NCM lithium battery, adjustable
09	Boost Voltage	[09] 57.6V Default	Setting of Boost Voltage: Set Range of 48V~58.4V, Step 0.4V, available when the battery type is user-defined and lithium battery.
10	Maximum Boost Duration	[10] 120 Default	Setting of Maximum Boost Duration, which is the maximum charging time when the voltage reaches the Parameter [09] when charging at

			constant voltage, with the Set Range of 5min~900min, and Step of 5min. It is available when the battery type is user-defined and lithium battery.
11	Float charge voltage	[11] 55.2V Default	Floating Charge Voltage, with the Set Range of 48V~58.4 V, Step of 0.4 V, and available when battery type is user-defined.
12	Over-discharge voltage	[12] 42V Default	Over-discharge Voltage: the battery voltage is lower than such criterion, and the Inverter output is turned off after the time delay parameter is set to [13], with the Set Range of 40V~48V and Step of 0.4V. available when the battery type is user-defined and lithium battery.
13	Over discharge Delay Time	[13] 5S Default	Over-discharge Delay Time: when the battery voltage is lower than the Parameter [12], the inverter output is turned off upon delay of time set by this Parameter, with the Set Range of 5S~50S, Step of 5S, available when the battery type is custom and lithium battery.
14	Battery under voltage alarm point	[14] 44V Default	Battery under-voltage alarm point: when the battery voltage is lower than such criterion, under-voltage alarm will be given, the output will not be shut down, with the Set Range of 40V~52V, Step of 0.4V, available when battery type is user-defined and lithium battery.
15	Battery Discharge Limit Voltage	[15] 40V Default	Battery Discharge Limit Voltage: the battery voltage is lower than such criterion, output and shut down immediately. Set Range of 40V~52V, Step of 0.4V, available when the battery type is user-defined and lithium battery.

16	Equalization charge	[16] DIS	No equalization charging
		[16] ENA Default	Enable equalization charging, only Flooded lead-acid batteries, sealed lead-acid batteries and user-defined are effective
17	Equalization Voltage	[17] 58V Default	Equalization Charging Voltage, with the Set Range of 48V~58V, Step of 0.4V, available for Flooded lead-acid battery, sealed lead-acid battery and user-defined
18	Equalization Charging Time	[18] 120 Default	Equalization Charging Time, with the Set Range of min~900min, Step of 5min, available for Flooded lead-acid battery, sealed lead-acid battery and user-defined
19	Equalized Charging Delay	[19] 120 Default	Equalization Charging Delay, with the Set Range of min~900min, Step of 5min, available for Flooded lead-acid battery, sealed lead-acid battery and user-defined
20	Equalization Charge Interval Time	[20] 30 Default	Equalization Charge Interval Time, 0~30d, Step of 1d, available for Flooded lead-acid battery, sealed lead-acid battery and user-defined
21	Equalization Charging Start-Stop	[21] ENA	Start equalization charging immediately
		[21] DIS Default	Stop equalization charging immediately
22	ECO mode	[22] DIS Default	NO ECO mode
		[22] ENA	When the ECO mode is enabled, if the load is below 50W, the inverter output is delayed for 5 minutes and then the output is turned off. When the hull switch is pressed to the "OFF" State, and then pressed to the "ON" State, the inverter will resume the output

23	Overload Automatic Restart	[23] DIS	Overload automatic restart is disabled. If overload occurs, the output will be shut down, and the machine will not be restarted.
		[23] ENA Default	Enable overload auto restart. If overload occurs, shut down output, delay the machine for 3 min and then restart the output. After 5 times in total, no startup will be resumed.
24	Auto restart upon over-temperature	[24] DIS	Over-temperature automatic restart is disabled. If over-temperature occurs, the output will be shut down, and the machine will not be restarted for output.
		[24] ENA Default	Enable automatic restart upon over-temperature. If over-temperature occurs, shut down output, and restart output after the temperature has dropped.
25	Buzzer Alarm	[25] DIS	No Alarm
		[25] ENA Default	Enable alarm
26	Mode Change Reminder	[26] DIS	Alarm is disabled when the status of the main input source has change.
		[26] ENA Default	Alarm is disabled when the status of the main input source has change.
27	Inverter Overload to Bypass	[27] DIS	Automatic switch to Mains Power is disabled when the Inverter is overloaded.
		[27] ENA Default	Automatic switch to Mains Power when the inverter is overloaded.
28	Current of charging under grid electricity	[28] 60A Default	AC output 230Vac, with the Set Range of 0~60A
		[28] 40A Default	AC output 120Vac, with the Set Range of 0~40A
30	RS485 Address Setting	[30] 1 Default	RS485 communication address can be set within the range of 1~254

31	AC output mode (can be set in the standby mode only)	[31] SIG Default	Single machine setting (for S & U model)
		[31] PAL	Single-phase parallel connection setting (for S & U model)
		[31] 2P0/2P1/2P2	Split-phase parallel connection setting (for U model)
		<p>When the parameter [38] setting item=120 for U series model. All connected P1-phase inverters are set to "2P0":</p> <p>1) If all connected P2-phase inverters are set to "2P1", AC output line voltage difference is 120 degrees (L1-L2), line voltage is $120 \times 1.732 = 208\text{Vac}$; Phase voltage is 120Vac (L1-N; L2-N).</p> <p>2) If all connected P2-phase inverters are set to "2P2", AC output line voltage difference is 180 degrees (L1-L2), line voltage is $120 \times 2 = 240\text{Vac}$; Phase voltage is 120Vac (L1-N; L2-N).</p>	
		[31] 3P1/3P2/3P3	Three-phase parallel connection setting (for S & U model)
<p>All machines in phase 1 must be set as [3P1] All machines in phase 2 must be set as [3P2] All machines in phase 3 must be set as [3P3]</p> <p>1. When the output voltage set in the setting [38] is 120 Vac (U model)</p> <p>At present the line voltage between L1 in phase 1 and L2 in phase 2 is $120 \times 1.732 = 208\text{ Vac}$, similarly the line voltage between L1-L3, L2-L3 is 208 Vac; the single phase voltage between L1-N, L2-N, L3-N is 120 Vac.</p> <p>2. When the output voltage set in the setting [38] is 230Vac (S model)</p> <p>At present the line voltage between the live wire L1 in phase 1 and the live wire L2 in phase 2 is $230 \times 1.732 = 398\text{Vac}$, and similarly the line voltage between L1-L3, L2-L3 is 398Vac; the single phase voltage between L1-N, L2-N, L3-N is 230Vac.</p>			
32	Communication function	[32]SLA default	RS485-2 port for PC or telecommunication control.
		[32] 485	RS485-2 port for 485-BMS communication.
33	BMS communication	When [32] enables BMS communication, the corresponding lithium battery manufacturer brand should be selected for communication	

	protocol	PAC=PACE, RDA=Ritar, AOG=ALLGRAND BATTERY, OLT=OLITER, HWD=SUNWODA, DAQ=DAKING, WOW=SRNE, PYL=PYLONTECH, UOL=WEILAN	
34	PV grid-connected power generation function	[34] DIS Default	Disable this Function
		[34] TOGRID	In the utility bypass state, when no battery is connected or when the battery is full, the surplus PV energy is fed back to the grid.
		[34] TOLOAD	In the utility bypass state, when no battery is connected or when the battery is full, the load power is supplied by the hybrid of PV and the utility.
35	Battery Under-voltage Recovery Point	[35] 52V Default	When the battery is under-voltage, the battery voltage should be greater than this set value to restore the inverter AC output of the battery, and the set range is 44V~54.4V.
36	Max PV charger current	[36] 80A default	Max PV charger current. Setting range: 0~100A
37	Battery Recharge Recovery Point	[37] 52V Default	After the battery is fully charged, the inverter will stop charging, and when the battery voltage is lower than this Value, the Inverter will resume charging again. And the set range is 44V~54V.
38	AC Output Rated Voltage	[38] 230Vac Default	You can set: 200/208/220/240Vac
39	Charge current limiting method (when BMS is enabled)	[38] LC SET	Max. battery charging current not greater than the value of setting 【07】
		[38] LC BMS	Max. battery charging current not greater than the limit value of BMS
		[38] LC INV	Max. battery charging current not greater than the logic judgements value of the inverter.
40	1-section start charging time	[40] 00:00:00 Default	Set Range: 00: 00-23: 59: 00
41	1-section end	[41] 00:00:00 Default	Set Range: 00: 00-23: 59: 00

	charging time		
42	2-section start charging time	[42] 00:00:00 Default	Set Range: 00: 00-23: 59: 00
43	2-section end charging time	[43] 00:00:00 Default	Set Range: 00: 00-23: 59: 00
44	3-section start charging time	[44] 00:00:00 Default	Set Range: 00: 00-23: 59: 00
45	3-section end charging time	[45] 00:00:00 Default	Set Range: 00: 00-23: 59: 00
46	Sectional charging function	[46] DIS Default	Disable this Function
		[46] ENA	After the sectioned charging function is enabled, the power supply mode will change to BT1ST, and system will enable the mains power charging only in the set charging period or battery over discharge; If the sectioned discharge function is enabled at the same time, the power supply mode of the system will change to AC1ST, which only enable the mains charging in the set charging period, and switch to the battery inverter power supply mode in the set discharge period or when the mains power is off
47	1-section start discharging time	[47] 00:00:00 Default	Set Range: 00: 00-23: 59: 00
48	1-section end discharging time	[48] 00:00:00 Default	Set Range: 00: 00-23: 59: 00
49	2-section start discharging time	[49] 00:00:00 Default	Set Range: 00: 00-23: 59: 00
50	2-section end discharging time	[50] 00:00:00 Default	Set Range: 00: 00-23: 59: 00
51	3-section start discharging time	[51] 00:00:00 Default	Set Range: 00: 00-23: 59: 00
52	3-section end	[52] 00:00:00 Default	Set Range: 00: 00-23: 59: 00

	discharging time		
53	Sectional discharge function	[53] DIS Default	Disable this Function
		[53] ENA	After the sectioned discharge function is enabled, the power supply mode will change to AC1ST and the system will switch to battery inverter power supply only during the set discharge period or when the mains power is off
54	Current date setting	[54] 00:00:00 Default	Set Range: 00:01: 01-99:12:31
55	Current time setting	[55] 00:00:00 Default	Set Range: 00:00: 00-23:59: 59
56	Leakage protection function	[56] DIS Default	Disable this Function
		[56]ENA	Enable leakage protection function
57	Stop charging current	[57] 2A default	Charging stops when the default charging current is less than this setting
58	Discharge alarm SOC setting	[58] 15% default	SOC alarm when capacity is less than this set value (valid when BMS communication is normal)
59	Cut-off discharge SOC Settings	[59] 5% default	Stops discharging when the capacity is less than this setting (valid when BMS communication is normal)
60	Cut-off charge SOC Settings	[60]100% default	Stops charging when capacity is greater than or equal to this setting (valid when BMS communication is normal)
61	Switch to mains SOC Settings	[61] 10% default	Switch to mains when capacity is less than this setting (valid when BMS communication is normal)
62	Switch to inverter output SOC Settings	[62] 100% default	Switches to inverter output mode when capacity is greater than or equal to this setting (valid when BMS communication is normal)

4.3 Battery type parameters

For Lead-acid Battery :

Battery type Parameters	Sealed lead acid battery (SLD)	Colloidal lead acid battery (GEL)	Vented lead acid battery (FLD)	User-defined (User)
Overvoltage disconnection voltage	60V	60V	60V	36 ~ 60V (Adjustable)
Battery fully charged recovery point(setup item 37)	52V (Adjustable)	52V (Adjustable)	52V (Adjustable)	52V (Adjustable)
Equalizing charge voltage	58.4V	56.8V	59.2V	36 ~ 60V (Adjustable)
Boost charge voltage	57.6V	56.8V	58.4V	36 ~ 60V (Adjustable)
Floating charge voltage	55.2V	55.2V	55.2V	36 ~ 60V (Adjustable)
Undervoltage alarm voltage(01 fault)	44V	44V	44V	36 ~ 60V (Adjustable)
Undervoltage alarm voltage recovery point(01 fault)	Undervoltage alarm voltage+0.8V			
Low voltage disconnection voltage(04 fault)	42V	42V	42V	36 ~ 60V (Adjustable)
Low voltage disconnection voltage recovery point (04 fault)(setup item 35)	52V (Adjustable)	52V (Adjustable)	52V (Adjustable)	52V (Adjustable)
Discharge limit voltage	40V	40V	40V	36 ~ 60V (Adjustable)
Over-discharge delay time	5s	5s	5s	1 ~ 30s (Adjustable)
Equalizing charge duration	120 minutes	-	120 minutes	0 ~ 600 minutes (Adjustable)
Equalizing charge interval	30 days	-	30 days	0 ~ 250 days (Adjustable)
Boost charge duration	120 minutes	120 minutes	120 minutes	10 ~ 600 minutes (Adjustable)

For Lithium Battery :

Battery type Parameters	(NCM13)	(NCM14)	(LFP16)	(LFP15)	(LFP14)
Overvoltage disconnection voltage	60V	60V	60V	60V	60V
Battery fully charged recovery point(setup item 37)	50.4V (Adjustable)	54.8V (Adjustable)	53.6V (Adjustable)	50.4V (Adjustable)	47.6V (Adjustable)
Equalizing charge voltage	53.2V (Adjustable)	57.6V (Adjustable)	56.8V (Adjustable)	53.2V (Adjustable)	49.2V (Adjustable)
Boost charge voltage	53.2V (Adjustable)	57.6V (Adjustable)	56.8V (Adjustable)	53.2V (Adjustable)	49.2V (Adjustable)
Floating charge voltage	53.2V (Adjustable)	57.6V (Adjustable)	56.8V (Adjustable)	53.2V (Adjustable)	49.2 (Adjustable)
Undervoltage alarm voltage(01 fault)	43.6V (Adjustable)	46.8V (Adjustable)	49.6V (Adjustable)	46.4V (Adjustable)	43.2V (Adjustable)
Undervoltage alarm voltage recovery point(01 fault)	Undervoltage alarm voltage+0.8V				
Low voltage disconnection voltage(04 fault)	38.8V (Adjustable)	42V (Adjustable)	48.8V (Adjustable)	45.6V (Adjustable)	42V (Adjustable)
Low voltage disconnection voltage recovery point (04 fault)(setup item 35)	46V (Adjustable)	49.6V (Adjustable)	52.8V (Adjustable)	49.6V (Adjustable)	46V (Adjustable)
Discharge limit voltage	36.4V	39.2V	46.4V	43.6V	40.8V
Over-discharge delay time	30s (Adjustable)	30s (Adjustable)	30s (Adjustable)	30s (Adjustable)	30s (Adjustable)
Boost charge duration	120 minutes (Adjustable)	120 minutes (Adjustable)	120 minutes (Adjustable)	120 minutes (Adjustable)	120 minutes (Adjustable)

5. Other functions

5.1 Dry contact

Working principle: This dry contact can control the ON/OFF of the diesel generator to charge the battery. ① Normally, the terminals are that the NC-N point is closed and the NO-N point is open; ② When the battery voltage reaches the low voltage disconnection point, the relay coil is energized, and the terminals turn to that the NO-N point is closed while NC-N point is open. At this point, NO-N point can drive resistive loads: 125VAC/1A, 230VAC/1A, 30VDC/1A.

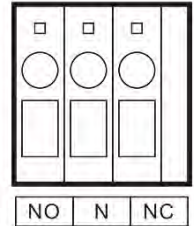

5.2 RS485 communication port

This port is an RS485 communication port which comes with two functions:

- ① RS485-2 allows direct communication with the optional host computer developed by our company through this port, and enables monitoring of the equipment running status and setting of some parameters on the computer;
- ② RS485-1/RS485-2 also allows direct connection with the optional RS485 to WiFi/GPRS communication module developed by our company through this port. After the module is selected, you can connect the all-in-one solar charge inverter through the mobile phone APP, on which you can view the operating parameters and status of the device.

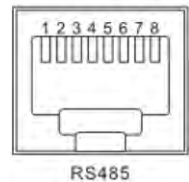

As shown in the figure:

RS485-1: Pin 1 is 5V power supply, Pin 2 is GND, Pin 7 is RS485-A1, and Pin 8 is RS485-B1;

RS485-2: Pin 1 is 5V power supply, Pin 2 is GND, Pin 7 is RS485-A2, and Pin 8 is RS485-B2;

5.3 USB communication port

This is a USB communication port, which can be used for USB communication with the optional PC host software. To use this port, you should install the corresponding "USB to serial chip CH340T driver" in the computer.

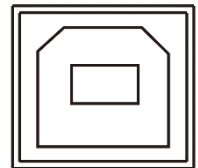

5.4 Parallel communication function (parallel operation only)

- a) This port is used for parallel communication, through which the parallel modules can communicate with each other.
- b) Each inverter has two DB15 ports, one for the male connector and the other for the female connector.
- c) When connecting, make sure to connect the male connector of the inverter with the female connector of the inverter to be paralleled, or connect the female connector of the inverter to the male connector of the inverter to be paralleled.
- d) Do not connect the male connector of the inverter to its female connector.

Female connector

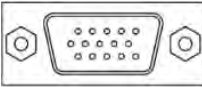

Male connector



5.5 Current sharing detection function (parallel operation only)

- a) This port is used for current sharing detection, through which the current sharing of the parallel modules can be detected (parallel operation only).
- b) Each inverter has two current sharing detection ports, which are connected in parallel. When it is connected to other models to be paralleled, either port can be connected for convenience. There is no special mandatory wiring requirements.

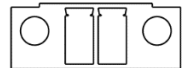

6. Protection

6.1 Protections provided

No.	Protections	Description
1	PV current/power limiting protection	When charging current or power of the PV array configured exceeds the PV rated, it will charge at the rated.
2	PV night reverse-current protection	At night, the battery is prevented from discharging through the PV module because the battery voltage is greater than the voltage of PV module.
3	Mains input over voltage protection	When the mains voltage exceeds 280V (230V model) or 140V (120V model), the mains charging will be stopped and switched to the inverter mode.
4	Mains input under voltage protection	When the mains voltage is lower than 170V (230V model /UPS mode), or 170V (230V model /UPS mode) or 90V (120V model or APL mode) the mains charging will be stopped and switched to the inverter mode.
5	Battery over voltage protection	When the battery voltage reaches the overvoltage disconnection point, the PV and the mains will be automatically stopped to charge the battery to prevent the battery from being overcharged and damaged.
6	Battery low voltage protection	When the battery voltage reaches the low voltage disconnection point, the battery discharging will be automatically stopped to prevent the battery from being over-discharged and damaged.
7	Load output short circuit protection	When a short-circuit fault occurs at the load output terminal, the AC output is immediately turned off and turned on again after 1 second.
8	Heat sink over temperature protection	When the internal temperature is too high, the all-in-one machine will stop charging and discharging; when the temperature returns to normal, charging and discharging will resume.
9	Overload protection	Output again 3 minutes after an overload protection, and turn the output off after 5 consecutive times of overload protection until the machine is re-powered. For the specific overload level and duration, refer to the technical parameters table in the manual.

10	PV reverse polarity protection	When the PV polarity is reversed, the machine will not be damaged.
11	AC reverse protection	Prevent battery inverter AC current from being reversely input to Bypass. (In off-grid mode)
12	Bypass over current protection	Built-in AC input overcurrent protection circuit breaker.
13	Battery input over current protection	When the discharge output current of the battery is greater than the maximum value and lasts for 1 minute, the AC input would switched to load.
14	Battery input protection	When the battery is reversely connected or the inverter is short-circuited, the battery input fuse in the inverter will blow out to prevent the battery from being damaged or causing a fire.
15	Charge short protection	When the external battery port is short-circuited in the PV or AC charging state, the inverter will protect and stop the output current.
16	CAN communication loss protection	In parallel operation, an alarm will be given when CAN communication is lost.
17	Parallel connection error protection	In parallel operation, the equipment will be protected when the parallel line is lost.
18	Parallel battery voltage difference protection	In parallel operation, the equipment will be protected when the battery connection is inconsistent and the battery voltage is greatly different from that detected by the host.
19	Parallel AC voltage difference protection	In parallel operation, the equipment will be protected when the AC IN input connection is inconsistent.
20	Parallel current sharing fault protection	In parallel operation, the running equipment will be protected when the load difference of each inverter is large due to improper connection of current sharing line or device damage.
21	Synchronization signal fault protection	The equipment will be protected when there is a fault in the guidance signal between parallel buses, causing inconsistent behavior of each inverter.

6.2 Fault code

Fault code	Fault name	Whether it affects the output or not	Description
[01]	BatVoltLow	NO	Battery undervoltage alarm
[02]	BatOverCurrSw	Yes	Battery discharge average current overcurrent software protection
[03]	BatOpen	Yes	Battery not-connected alarm
[04]	BatLowEod	Yes	Battery undervoltage stop discharge alarm
[05]	BatOverCurrHw	Yes	Battery overcurrent hardware protection
[06]	BatOverVolt	Yes	Charging overvoltage protection
[07]	BusOverVoltHw	Yes	Bus overvoltage hardware protection
[08]	BusOverVoltSw	Yes	Bus overvoltage software protection
[09]	PvVoltHigh	No	PV overvoltage protection
[10]	PvOCSw	No	Boost overcurrent software protection

【11】	PvOCHw	No	Boost overcurrent hardware protection
【13】	OverloadBypass	Yes	Bypass overload protection
【14】	OverloadInverter	Yes	Inverter overload protection
【15】	AcOverCurrHw	Yes	Inverter overcurrent hardware protection
【17】	InvShort	Yes	Inverter short circuit protection
【19】	OverTemperMppt	No	Buck heat sink over temperature protection
【20】	OverTemperInv	Yes	Inverter heat sink over temperature protection
【21】	FanFail	Yes	Fan failure
【22】	EEPROM	Yes	Memory failure
【23】	ModelNumErr	Yes	Model setting error
【26】	RlyShort	Yes	Inverted AC Output Backfills to Bypass AC Input
【29】	BusVoltLow	Yes	Internal battery boost circuit failure

【30】	BatCapacityLow1	No	Alarm given when battery capacity rate is lower than 10% (setting BMS to enable validity)
【31】	BatCapacityLow2	No	Alarm given when battery capacity rate is lower than 5% (setting BMS to enable validity)
【32】	BatCapacityLowStop	Yes	Inverter stops when battery capacity is low (setting BMS to enable validity)
【34】	CanCommFault	Yes	CAN communication fault in parallel operation
【35】	ParaAddrErr	Yes	Parallel ID (mailing address) setting error
【37】	ParaShareCurrErr	Yes	Parallel current sharing fault
【38】	ParaBattVoltDiff	Yes	Large battery voltage difference in parallel mode
【39】	ParaAcSrcDiff	Yes	Inconsistent AC input source in parallel mode
【40】	ParaHwSynErr	Yes	Hardware synchronization signal error in parallel mode
【41】	InvDcVoltErr	Yes	Inverter DC voltage error
【42】	SysFwVersionDiff	Yes	Inconsistent system firmware version in parallel mode
【43】	ParaLineContErr	Yes	Parallel line connection error in parallel mode

[44]	Serial number error	Yes	If the serial number is not set by omission in production, please contact the manufacturer to set it
[45]	Error setting of splitphase mode	Yes	[31] Settings item setting error
[58]	BMS communication error	No	Check whether the communication line is connected correctly and whether [33] is set to the corresponding lithium battery communication protocol
[59]	BMS alarm	No	Check the BMS fault type and troubleshoot battery problems
[60]	BMS battery low temperature alarm	No	BMS alarm battery low temperature
[61]	BMS battery over temperature alarm	No	BMS alarm battery over temperature
[62]	BMS battery over current alarm	No	BMS alarm battery over current
[63]	BMS battery undervoltage alarm	No	BMS alarm low battery
[64]	BMS battery over voltage alarm	No	BMS alarm battery over voltage

6.3 Handling measures for part of faults

Fault code	Faults	Remedy
Display	No display on the screen	Check if the battery the PV air switch has been closed; if the switch is in the "ON" state; press any button on the screen to exit the screen sleep mode.
[06]	Battery overvoltage protection	Measure if the battery voltage exceeds rated, and turn off the PV array air switch and Mains air switch.
[01] [04]	Battery undervoltage protection	Charge the battery until it returns to the low voltage disconnection recovery voltage.
[21]	Fan failure	Check if the fan is not turning or blocked by foreign object.
[19] [20]	Heat sink over temperature protection	When the temperature of the device is cooled below the recovery temperature, normal charge and discharge control is resumed.
[13] [14]	Bypass overload protection, inverter overload protection	① Reduce the use of power equipment; ② Restart the unit to resume load output.
[17]	Inverter short circuit protection	① Check the load connection carefully and clear the short-circuit fault points; ② Re-power up to resume load output.
[09]	PV overvoltage	Use a multimeter to check if the PV input voltage exceeds the maximum allowable input voltage rated.
[03]	Battery disconnected alarm	Check if the battery is not connected or if the battery circuit breaker is not closed.
[40] [43]	Parallel connection fault	Check whether the parallel line is not connected well, such as loose or wrong connection.
[35]	Parallel ID setting error	Check whether the setting of parallel ID number is repeated.
[37]	Parallel current sharing fault	Check whether the parallel current sharing line is not connected well, such as loose or wrong connection.
[39]	Inconsistent AC input source in parallel mode	Check whether the parallel AC inputs are from the same input interface.
[42]	Inconsistent system firmware version in parallel mode	Check whether the software version of each inverter is consistent.

7.Troubleshooting

- **In order to maintain the best long-term performance, it is recommended to conduct following checks twice a year.**
 1. Make sure that the airflow around the unit is not blocked and remove any dirt or debris from the heat sink.
 2. Check that all exposed wires are damaged by exposure to sunlight, friction with other objects around them, dryness, bite by insects or rodents, etc., and the wires shall be repaired or replaced if necessary.
 3. Verify for the consistency of indication and display with the operation of the device. Please pay attention to the display of any faults or errors, and take corrective actions if necessary.
 4. Check all wiring terminals for corrosion, insulation damage, signs of high temperature or burning/discoloration, and tighten the screws.
 5. Check for dirt, nesting insects and corrosion, and clean up as required.
 6. If the arrester has failed, replace in time to prevent lightning damage to the unit or even other equipment of the user.

Warning: Danger of electric shock! When doing the above operations, make sure that all power supplies of the all-in-one machine have been disconnected, and all capacitors have been discharged, and then check or operate accordingly!

- **The company does not assume any liability for damage caused by:**
 - ① Improper use or use in improper site.
 - ② Open circuit voltage of the PV module exceeds the maximum allowable voltage rated.
 - ③ Temperature in the operating environment exceeds the limited operating temperature range.
 - ④ Disassemble and repair the all-in-one solar charge inverter without permission.
 - ⑤ Force majeure: Damage that occurs in transportation or handling of the all-in-one solar charge inverter.

8. Technical parameters

Models	HYP4850S100-H	HYP4850U00-H
Parallel mode		
Permitted parallel number	1~6	
AC mode		
Rated input voltage	220/230Vac	110/120Vac
Input voltage range	(170Vac~280Vac) ±2% (90Vac~280Vac) ±2%	(90Vac~140Vac)±2%
Frequency	50Hz/ 60Hz (Auto detection)	
Frequency Range	47±0.3Hz ~ 55±0.3Hz (50Hz); 57±0.3Hz ~ 65±0.3Hz (60Hz);	
Overload/short circuit protection	Circuit breaker	
Efficiency	> 95%	
Conversion time (bypass and inverter)	10ms (typical)	
AC reverse protection	Available	
Maximum bypass overload current	40A	63A
Inverter mode		
Output voltage waveform	Pure sine wave	
Rated output power (VA)	5000	
Rated output power (W)	5000	
Power factor	1	
Rated output voltage (Vac)	230Vac (200/208/220/240Vac Settable)	120Vac (100/105/110Vac Settable)
Output voltage error	±5%	
Output frequency range (Hz)	50Hz ± 0.3Hz 60Hz ± 0.3Hz	
Maximum Efficiency	> 92%	
Overload protection	(102% < load <125%) ±10%: report error and turn off the output after 5 minutes;	(102% < load <110%) ±10%: report error and turn off the output after 5 minutes;

	(125% < load < 150%) ± 10%: report error and turn off the output after 10 seconds; Load > 150% ± 10%: report error and turn off the output after 5 seconds	(110% < load < 125%) ± 10%: report error and turn off the output after 10 seconds; (Load > 125% ± 10%): report error and turn off the output after 5 seconds;
Peak power	10000VA	
Loaded motor capability	4HP	
Rated battery input voltage	48V (Minimum starting voltage 44V)	
Battery voltage range	Undervoltage alarm/shutdown voltage/overvoltage alarm /overvoltage recovery... settable on LCD screen)	
Power saving mode self-consumption	Load ≤ 50W	
AC Output (Grid)		
Rated Output Power (W)	5000W	
Max. apparent power (VA)	500VA	
Max. output current (A)	21.7A	41.7A
THDI	< 3%	
Rated voltage(V)	230Vac	120Vac
Frequency	50Hz/60Hz	
AC charging		
Battery type	Lead acid or lithium battery	
Maximum charge current(can be set)	0-60A	0-40A
Charge current error	± 3A _{dc}	
Charge voltage range	40 ~58V _{dc}	
Short circuit protection	Circuit breaker and blown fuse	
Circuit breaker specifications	40A	63A
Overcharge protection	Alarm and turn off charging after 1 minute	
PV charging		
Maximum PV open circuit voltage	500V _{dc}	

PV operating voltage range	120-500Vdc	
MPPT voltage range	120-450Vdc	
Battery voltage range	40-60Vdc	
Maximum PV input power	5500W	
Maximum PV input current	22A	
PV charging current range (can be set)	100A	
Charging short circuit protection	Blown fuse	
Wiring protection	Reverse polarity protection	
Hybrid charging Max charger current specifications (AC charger+PV charger)		
Max charger current(can be set)	100A	
Certified specifications		
Certification	CE(IEC62109-1)	
EMC certification level	EN61000	
Operating temperature range	-10°C to 55°C	
Storage temperature range	-25°C ~ 60°C	
Humidity range	5% to 95% (Conformal coating protection)	
Noise	≤60dB	
Heat dissipation	Forced air cooling, variable speed of fan	
Communication interface	USB/RS485(WiFi/GPRS)/Dry contact control	
Dimension (L*W*D)	446.9mm*350mm*133mm	
Weight	13kg	14kg